

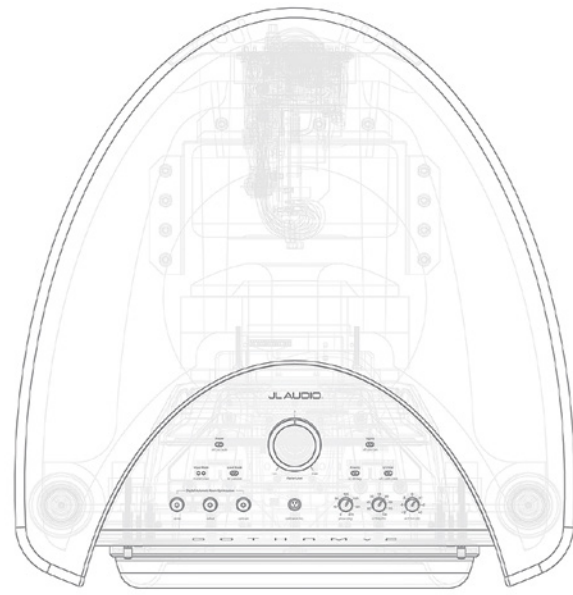

Engineered and built to perform like no other.



Gotham g213 v2



Dominion d110

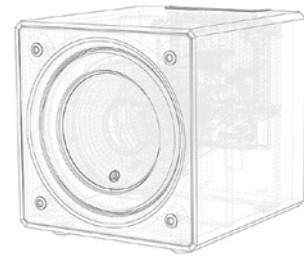

E-Sub v112

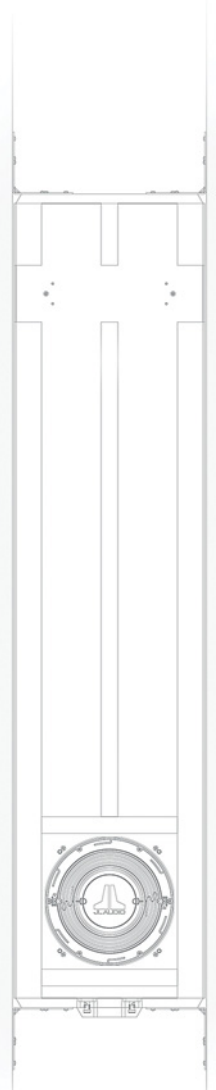

Fathom IWS-108

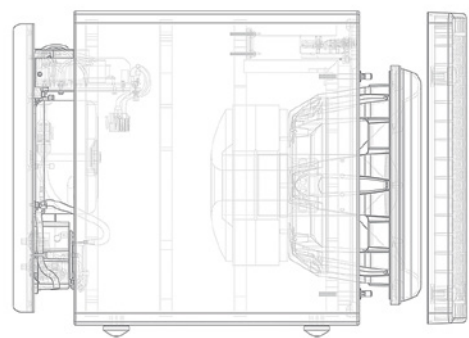

Fathom f113 v2

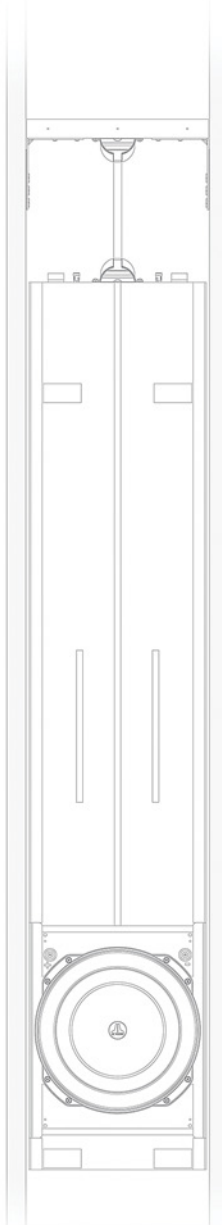

Fathom IWSv2-113

JL AUDIO® | How we play.®

JL Audio is a private, specialty audio company founded in 1975 and headquartered in Miramar, Florida USA. We design and build high performance products for Home, Marine and Automotive audio, employing over 500 people in our three U.S. facilities.



Miramar, Florida

206,000 sq.ft. (19,138 m²)

Company Headquarters

Loudspeaker Engineering

Loudspeaker Manufacturing

Enclosure Manufacturing

Service Center

Distribution Center



Phoenix, Arizona

55,200 sq.ft. (5,128 m²)
Electronics Engineering
Electronics Service Center
Distribution Center



Portland, Oregon

4668 sq.ft. (434 m²)
Electronics Engineering
Software/Firmware Engineering
DSP Engineering

JL AUDIO

10301-10393 N Commerce Parkway





Contents

- 08 Technologies:**
Loudspeaker
- 10 Technologies:**
Electronics
- 12 Model Overview:**
In-Room Subwoofers
- 14 Gotham®**
In-Room Subwoofer
- 20 Fathom®**
In-Room Subwoofers
- 28 E-Sub™**
In-Room Subwoofers
- 34 Dominion®**
In-Room Subwoofers
- 40 Model Overview:**
Architectural Subwoofer Systems
- 42 8-in Fathom® IWS/ICS**
In-Wall/In-Ceiling Subwoofer Systems
- 46 13.5-in Fathom® IWS**
In-Wall Subwoofer Systems
- 52 CR-1**
Active Subwoofer Crossover
- 53 JLINK™**
Wireless Audio Transmitter & Receiver Kit
- 54 Features & Specifications:**
All Models



Loudspeaker Technology

Every project starts with a unique driver.

In every subwoofer design, the driver establishes the performance envelope and is the primary factor in the quality of the end result. Getting it wrong at this fundamental loudspeaker level means having to accept distortion and non-linearities in the final product. We insist on getting the driver right and building everything else around it.

As a designer and builder of loudspeakers, JL Audio has the luxury to center every home subwoofer project on a unique driver design— one which is precisely aimed at the physical and performance goals of the project.

We apply proprietary modeling systems to study loudspeaker motor, suspension and structural behaviors and use the most advanced test systems in the industry to verify the results. These practices, and our decades of loudspeaker design experience, provide insights and breakthroughs that lead to world-class results.

Never reluctant to innovate, nor to create new loudspeaker parts for a project, we find that investments leading to better performance and reliability are always well-spent. This position extends to the manufacturing of our home subwoofer drivers. We source the finest materials and components globally, but we build every one in our state-of-the-art USA factory.

JL Audio's driver technology and precision assembly together form a fundamental advantage you will not find in other subwoofers.



Fathom® and Gotham®

Gotham® and Fathom® in-room subwoofers are centered on JL Audio's highest technology subwoofer design: W7-HT. Each model-specific drive unit features extreme excursion capability, with outstanding linearity and dynamic stability.

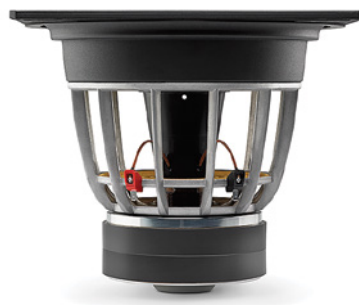

E-Sub™

E-Sub™ drivers are distinguished by a radical, widely-spaced suspension architecture and a steel structure that forms the outer baffle of the subwoofer enclosure.



Dominion®

These compact drivers feature a massive cast-alloy frame and several unique JL Audio technologies to deliver class-leading audio quality.



Fathom® IWS 13.5-inch

The remarkable TW5v2 driver is capable of outstanding cone excursion, from a driver with minimal overall depth. It is the key to our unbeatable Fathom® 13.5-inch, in-wall subwoofer solution.



Fathom® IWS/ICS 8-inch

An engineering marvel with a unique motor and suspension design that extracts every millimeter of excursion possible from its slim mounting depth. Nothing like it existed, so we designed and built it.

DMA-Optimized Motor System

JL Audio's proprietary Dynamic Motor Analysis system is a powerful suite of FEA-based modeling systems, refined over the years to scientifically address the challenges of speaker motor linearity. The insights gained through DMA results in vastly reduced distortion and faithfully reproduced transients... or put simply: tight, clean, articulate bass. This technology is applied to all JL Audio loudspeakers.

OverRoll™ Surround

(U.S. Patent #6,568,503)

An innovative attachment method for the loudspeaker's outer suspension maximizes cone area, while allowing excellent control of excursion. Applied in Fathom® and Gotham® in-room subwoofers.

W-Cone™

(U.S. Patent #6,496,590)

The W-Cone used in the W7-HT drivers is a unit-body cone assembly that delivers astonishing cone stiffness with minimal mass. Applied in Fathom® and Gotham® in-room subwoofers.

Engineered Lead Wire Management

(U.S. Patent #7,356,157)

Our proprietary method for connecting the wiring terminals to the voice coil is designed to reduce mechanical fatigue, eliminate noise, and deliver ample current. Used in all models.

Floating-Cone™ Attach Method

(U.S. Patent #6,501,844)

This precision-assembly technique, invented by JL Audio, ensures proper suspension geometry in the assembled speaker, for better excursion control and voice coil alignment. Applied in all in-room subwoofers.

Motor Attachment Method

(U.S. Patent #8,335,337)

An integral part of our remarkable TW5v2 thin-line design, this patented technology facilitates precision assembly. Used in our 13.5-inch in-wall subwoofer systems.

Elevated Frame Cooling Technology

JL Audio's Elevated Frame Cooling design creates air flow through slots directly above the top-plate to the voice coil of the loudspeaker, to enhance power handling and to minimize power compression. Applied in all in-room subwoofers.

Concentric Tube Suspension

This breakthrough JL Audio invention creates mechanical clearance comparable to a normal-depth subwoofer in a thin-line subwoofer design. Applied in all in-wall/in-ceiling subwoofers.



The Fathom® v2 Family features DSP and JL Audio's exclusive D.A.R.O. technology.

Electronics Technology

In addition to a top-quality driver, the performance of a powered subwoofer system depends heavily on its electronics package, where amplification and precision signal processing need to work as one.



The Gotham® g213v2

Our flagship in-room subwoofer includes JL Audio's exclusive D.A.R.O. technology, a powerful DSP, and 4,500 watts of clean amplifier power.



The SA v2 Subwoofer Amplifier

With built-in DSP, D.A.R.O. technology, and up to 2000 watts of power from a massive amplifier, the 13.5-inch Fathom® IWS systems compare very favorably with the best in-room subwoofers.



The SA-600W Amplifier

To maximize performance in any room, our Fathom® IWS and ICS-108 systems include this slim 1U subwoofer amplifier with DSP and D.A.R.O. technology.



Essential Amplification

An inherent challenge in the design of a compact subwoofer system is that extremely high power is required to reproduce strong, deep bass from small enclosures. The driver needs to be up to the task of handling the heat and excursion, and the amplifier must provide high levels of clean, controlled power. If either one falls short, you begin to hear distortion and dynamics lose their realistic edge.

JL Audio launched its first switching Class-D amplifier design over two decades ago, at a time when the technology was just emerging. Over the past twenty years, we have continually refined our amplifiers, applying unique solutions to the specific challenges of low frequency performance.

From the 500 watt amplifier in the tiny d108, to the massive 4,500 watt unit built into our flagship Gotham®, every JL Audio subwoofer amplifier is a unique design, not available anywhere else in the world, and perfectly matched to its application.

Signal Processing

Signal processing plays several vital roles in a powered subwoofer; enabling user-adjustable features, providing room response optimization, and controlling the baseline performance of the subwoofer system.

With expertise in both analog and digital signal processing, we apply the appropriate technology in each subwoofer design. Gotham® and Fathom® systems apply digital signal processing (DSP), while E-Sub™ and Dominion® systems rely on analog processing.

Every model offers a series of adjustment controls, designed to help integrate your subwoofer(s) with your audio system and your listening space.

Digital Automatic Room Optimization

In typical listening spaces, subwoofer and listener placement have a profound effect on the accuracy of low-frequency reproduction. We always recommend that you place your subwoofers in good-sounding locations, but we know that real world concerns can get in the way. In a home, subwoofer placement almost always involves a compromise between sonic performance, practicality, and aesthetics.

To address this dilemma head on, we developed a technology called Digital Automatic Room Optimization (D.A.R.O.). It is extremely powerful, yet simple to use. You will not need a computer or complex measurement equipment.

Once you have placed your Gotham® or Fathom® subwoofer in your room, you will connect the calibration microphone to your subwoofer, place the microphone at the listening position, and press a button. The subwoofer will self-generate a series of test signals, which allows D.A.R.O. to measure your room's low frequency acoustics. Once the measurements are completed, D.A.R.O. will automatically configure the subwoofer's DSP (specifically its 18-band, 1/6 octave equalizer) to optimize the frequency response of your JL Audio subwoofer for your room and your listening position.

D.A.R.O. is included in all Gotham® and Fathom® models, including the IWS and ICS systems. The D.A.R.O. calibration microphone is included with all models, except the 8-inch Fathom® IWS and ICS systems.



g213v2-GLOSS
Dual 13.5-inch (345 mm)
Powered Subwoofer
Black Gloss Finish



Think in pairs!
Deploying two subwoofers will improve the smoothness, power and consistency of the bass in your listening space.

In-Room Powered Subwoofers

Great subwoofers are an essential foundation to a world-class audio system—stereo, or multi-channel.

They are also our specialty.

From the diminutive d108, to the awe-inspiring Gotham®, JL Audio in-room powered subwoofers have received the highest accolades from audio reviewers and demanding audiophiles around the world.

FATHOM®



f212v2-GLOSS
Dual 12-inch (300 mm)
Powered Subwoofer
Black Gloss Finish



f113v2-GLOSS
13.5-inch (345 mm)
Powered Subwoofer
Black Gloss Finish



f112v2-GLOSS
12-inch (300 mm)
Powered Subwoofer
Black Gloss Finish



f110v2-GLOSS
10-inch (250 mm)
Powered Subwoofer
Black Gloss Finish

E-SUB



e112-GLOSS
12-inch (300 mm)
Powered Subwoofer
Black Gloss Finish



e112-ASH
12-inch (300 mm)
Powered Subwoofer
Black Ash Finish



e110-GLOSS
10-inch (250 mm)
Powered Subwoofer
Black Gloss Finish



e110-ASH
10-inch (250 mm)
Powered Subwoofer
Black Ash Finish

DOMINION®



d110-GLOSS
10-inch (250 mm)
Powered Subwoofer
Black Gloss Finish



d110-ASH
10-inch (250 mm)
Powered Subwoofer
Black Ash Finish



d108-GLOSS
8-inch (200 mm)
Powered Subwoofer
Black Gloss Finish



d108-ASH
8-inch (200 mm)
Powered Subwoofer
Black Ash Finish

“The Gotham g213 produces state-of-the-art bass that will improve the highest of high-end systems. I’ve heard no other subwoofer that can match it.”

– Jeff Fritz, [Ultra Audio](#)

“This subwoofer really leaves former subwoofer-hater Jonathan Valin at a loss for words. It is so good at what it does—which is deliver power, clarity, color, texture, and sheer oomph in the bottom octaves—**that he’s never heard anything that can beat it in the bass,** either in a subwoofer or a full-range floorstander.”

– [The Absolute Sound](#), Editors’ Choice Awards

“Subwoofers of the Gods”

– Chris Martens, [The Perfect Vision](#)

“While it’s true that you should never judge a book by its cover or a subwoofer by its luxurious, hand-rubbed gloss-black finish, one look at the Gotham g213 creates instant desire.”

– Darryl Wilkinson - [Home Theater](#)

“...the Gotham is a massively overbuilt (think “mil-spec”) subwoofer that doesn’t know the meaning of the term ‘dynamic constraints’.”

– [The Perfect Vision](#)

There is apparently information in the subsonic region that fills out the sound of a concert hall. Once you’ve heard it, you can’t go back.

– Jacob Heilbrunn, [TONEAudio](#)

GOTHAM[®] v2





The Gotham® v2's massive fiberglass-composite enclosure is built in our Florida factory from its skeletal bracing outward, in a construction process which takes place over several days. Multiple closely guarded steps are followed to create an acoustically inert structure. Each Gotham® v2 is then hand-finished in luxurious gloss-black, complemented by machined accents and a cleverly engineered grille system designed for cosmetic flexibility.

King of bass.

The Gotham® g213v2 is the unfettered expression of JL Audio's commitment to beautiful design, exceptional build quality, and truly great audio. Its devastating combination of extension, accuracy, and power unleashes your main speakers to do what they do best, transforming your listening experience in profound ways.

Listening to a Gotham® v2 reveals an entirely new dimension of subwoofer performance... a dimension so satisfying that listening to lesser subwoofers will forever become an act of compromise.



With the included, laboratory-grade calibration microphone, JL Audio's powerful Digital Automatic Room Optimization (D.A.R.O.) deploys a powerful DSP to adjust the Gotham's response for optimal performance in your listening room.



The beautiful control panel of the Gotham® v2 provides convenient access to its signal processing adjustments, D.A.R.O. functions, and a jewel-like Master Level control knob.



Inside each Gotham® v2 are two of JL Audio's highest-technology subwoofer drivers, driven by a mind-numbing 4,500 watts of clean, controlled power from a proprietary, patented Class D amplifier. This combination yields over four inches of peak-to-peak driver excursion capability, with extremely low distortion at all listening levels.



Separate woofer and control panel grilles allow control access without removing the larger grille and also offer a choice of three distinct visual presentations.

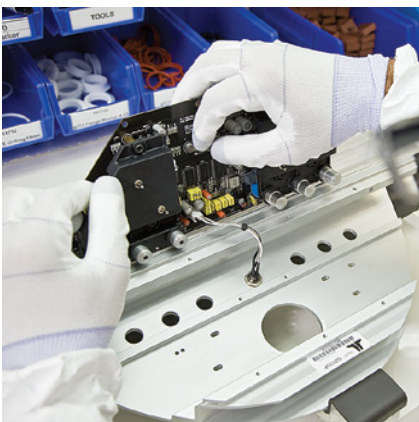
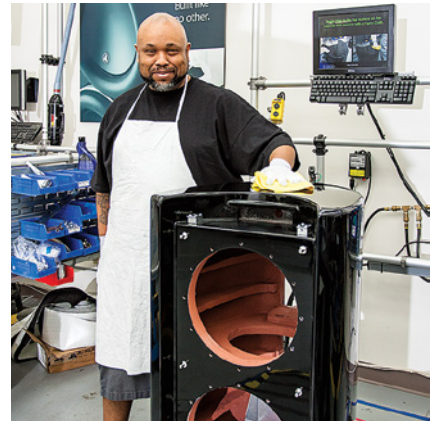

Gotham® Manufacturing

Each Gotham® enclosure takes weeks to produce in our Miramar, Florida factory, passing through multiple phases of fabrication and finishing. The body of the enclosure is molded in solid fiberglass with proprietary damping technologies and carefully engineered internal bracing to create a highly inert structure. Wall thickness exceeds 1-inch (25 mm) and requires precision CNC equipment to perform secondary machining of all openings. Our skilled craftsmen prepare, finish, and hand polish each one to the highest furniture-grade standards. Final assembly, inspection and testing are carried out in a highly controlled environment to ensure that the Gotham's function is every bit as impressive as its form. No other subwoofer in the world is built like this and no other subwoofer performs like it.



Gotham[®] v2 Subwoofer

Massive Switching Power Amplifier rated for 4500 Watts of mind-numbing power and control.

Massive Fiberglass-Composite Enclosure Construction

Net Weight: 360 lbs. (163 kg)

Sophisticated digital signal processing, including JL Audio's Digital Automatic Room Optimization System (D.A.R.O.)

Built in USA with Global Components

Top-mounted controls make setup easy and comfortable.

Spectacular gloss-black cabinet finish

Twin, ultra-high excursion, JL Audio[®] 13W7-HT's, our most potent subwoofer drivers

DEVASTATING BASS



“If it weren’t just a subwoofer,
this would be a national treasure
– or a secret weapon.”

Home Theater magazine, Feb/March 2013

“It was masterfully
awe-inspiring.”

– Darryl Wilkinson, Home Theater

FATHOM®





“The JL Audio Fathom is of reference quality,
and a benchmark by which
all other subwoofers can be judged.”

– Robert Harley, *The Perfect Vision*, (On the Fathom f113)

The Benchmark.

The challenges associated with designing high-output, compact subwoofer systems can be daunting. In most cases, designers sacrifice low-frequency extension or output capability in order to keep a design acceptably small.

The Fathom® subwoofers sacrifice nothing, thanks to the dynamic advantages of their proprietary JL Audio drivers. The ultra-compact f110v2 is perfect for small spaces and media rooms. The f112v2 is also compact, and powerful enough to anchor serious home theater setups, or equally at home in the most critical music listening applications. The f113v2 combines prodigious output capabilities with outstanding finesse and low distortion. (A pair of f113v2's will satisfy the most demanding home theater or pro studio applications.) The f212v2's dual driver configuration and ultra-powerful amplifier deliver the highest performance of the Fathom® lineup. A pair of them may create seismic events.





JL Audio's Digital Automatic Room Optimization (D.A.R.O.) smooths frequency response, even in difficult rooms. Connect the included calibration microphone, place it in your listening position, and press a button. Your Fathom® takes care of the rest.

The value of deploying multiple subwoofers cannot be overstated. This is especially true if the goal is to provide consistent bass response in a wide seating area for multiple listeners. In this theater, a pair of f212v2's flank a pair of f112v2's.



“Stereo with one f110v2 or multichannel with three were equally ravishing, save for the ingratiating ambience of multichannel.”

- Kal Rubinson, [Stereophile](#)

“Subwoofer of the Year”

- [The Perfect Vision](#)

“The JL f110v2 is a mighty-mite of a sub, conceding little to its larger brothers.”

- Kal Rubinson, [Stereophile](#)

“Golden Ear Award”

- [Absolute Sound](#), (Fathom f113)

“What are they, exactly? I can’t answer that in a nutshell. Not if you want more specific than fantastic. The condensed version is that they are relatively small, insanely well-built, extremely powerful, very smooth, tight, detailed to a fine line, clean, poise-laden, dynamically proficient, utterly kick-ass subwoofers.”

- Colin Miller, [Secrets of Home Theater and High Fidelity](#)

“Class A – Recommended Component”

- [Stereophile](#)

“Reviewers’ Choice”

- [Home Theater & Sound](#), (Fathom f113)

“But do they ROCK?”

The answer to that question is YES!”

- Jeff Dorgay, [TONEAudio](#), (Fathom® f110)

“Two JL Audio Fathom f113 subwoofers produced dramatic changes in my audio system. Never before had new audio gear reshaped the depth and width of the soundstage, doubled the dynamic range, and increased the transparency, all at the same time.”

“The Fathoms’ reproduction of double bass had ear-boggling dynamics and pace.”

- Larry Greenhill, [Stereophile](#)



To extract the full benefit from the excursion envelope of its woofer design, each Fathom® employs an uncommonly powerful amplifier with a large toroidal transformer, and proprietary switching technology, designed to enhance control and fidelity.



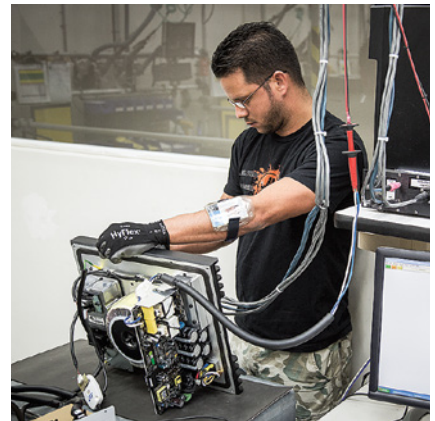

Fathom® Assembly

Our Fathom® assembly process brings together all the key component groups: drivers, electronics, wire harnesses and enclosures. Drivers are individually tested at the end of their build process, only about 100 ft (30 m) away from this assembly room. Before assembly begins, electronics and wire harnesses are connected and tested together, ensuring they meet our full specification as a complete system. Enclosures are also carefully inspected for integrity and finish using specialized lighting. From there, components are placed on a cart and moved to one of our assembly stations, where a single technician assumes responsibility for the complete assembly process. Because of the weight of our subwoofers, motorized lifts and turntables are used to assist the assembly technician, who follows a documented, step-by-step process, using a series of calibrated tools that ensure correct torque for each fastener. The completed units are placed on their carts, where they make a short trip to our testing room for a series of critical performance and electrical tests.



Fathom[®] f113v2 Subwoofer

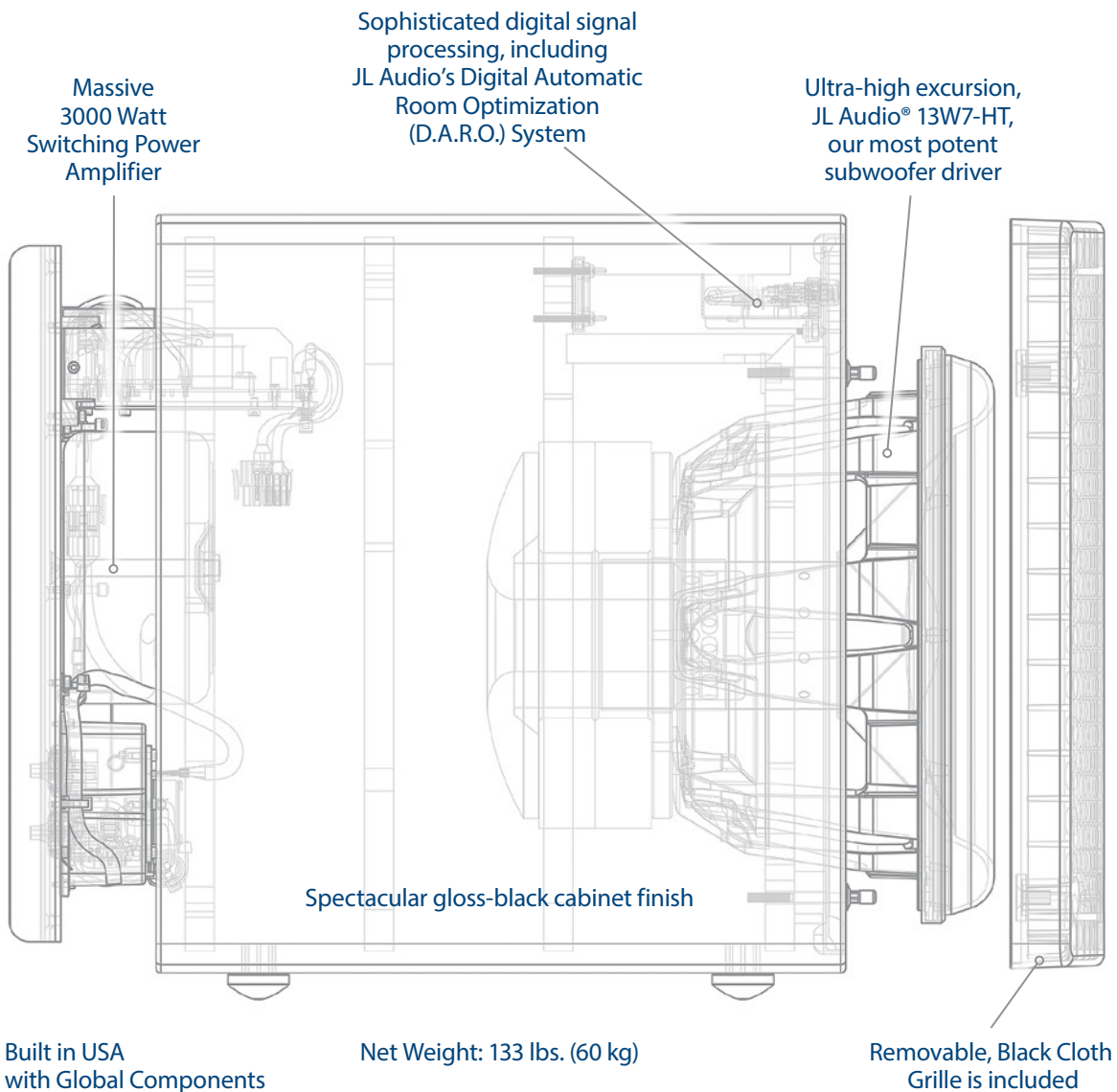

Editors' Choice

- 2008-2019, *The Absolute Sound*

THE BENCHMARK



E-SUB





“the no-brainer buy of the year.”

– Jeff Fritz, Soundstage! Network

Product of the Year - e112

Exceptional Value: Subwoofers

- Soundstage! Network



E-SUB

Game-changer.

E-Sub™ subwoofers benefit from a series of our key technologies to deliver exceptional sound quality, power, and value in a wide range of demanding applications, from full home theater systems to dedicated two-channel music systems, to desktop audio workstations.

The E-Sub™ driver's distinctive mechanical design offers several advantages. The driver attaches to the front of the enclosure via a steel collar that forms the front baffle of the E-Sub™, while a threaded motor back plate affixes the driver to the rear wall of the enclosure. This forms a beam structure to support the weight of the driver, while creating a very rigid enclosure.



A true, two-way onboard crossover with high-pass line outputs allows for seamless integration with two-channel systems, while high-level inputs also make it possible to add an E-Sub™ to systems lacking line outputs.



With top mounted controls, making adjustments is very straightforward (and comfortable). A magnetically held cover is provided to conceal and protect the controls.

Every E-Sub™ powered subwoofer is precision-built, with global components, and fully tested in JL Audio's U.S. factory to deliver years of listening enjoyment in your home audio or home theater system.

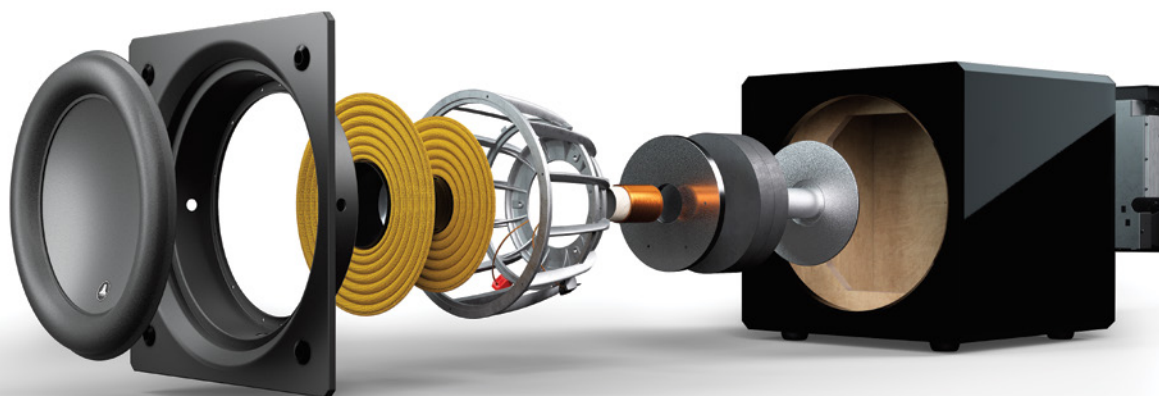

Inside each E-Sub™, a state-of-the-art, long excursion JL Audio driver combines with a highly efficient, proprietary switching amplifier to deliver astonishing performance from a very compact subwoofer cabinet.

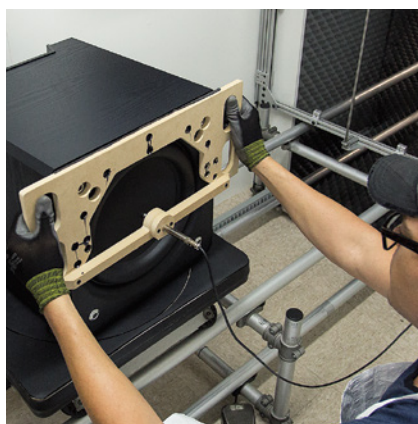

E-Sub™ Manufacturing

The E-Sub™ driver is an unconventional design, requiring very specific production fixtures and procedures. As one of our highest technology subwoofer drivers, it is built by the same team that assembles our flagship W7-HT drivers, and is tested to the same quality standards. Final assembly of every E-Sub™ takes place in our Miramar, Florida factory, where skilled technicians bring together the driver, enclosure, and electronics package. A full acoustical and electrical test takes place at the end of the production line, to verify the performance of each finished subwoofer.



E-Sub™ e112 Subwoofer

Top-mounted controls make setup easy and comfortable.

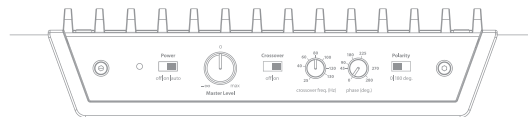

Radical, long-excursion driver design with extremely deep cast alloy frame and steel baffle plate.

Proprietary 1500 Watt switching amplifier with integrated signal processing.

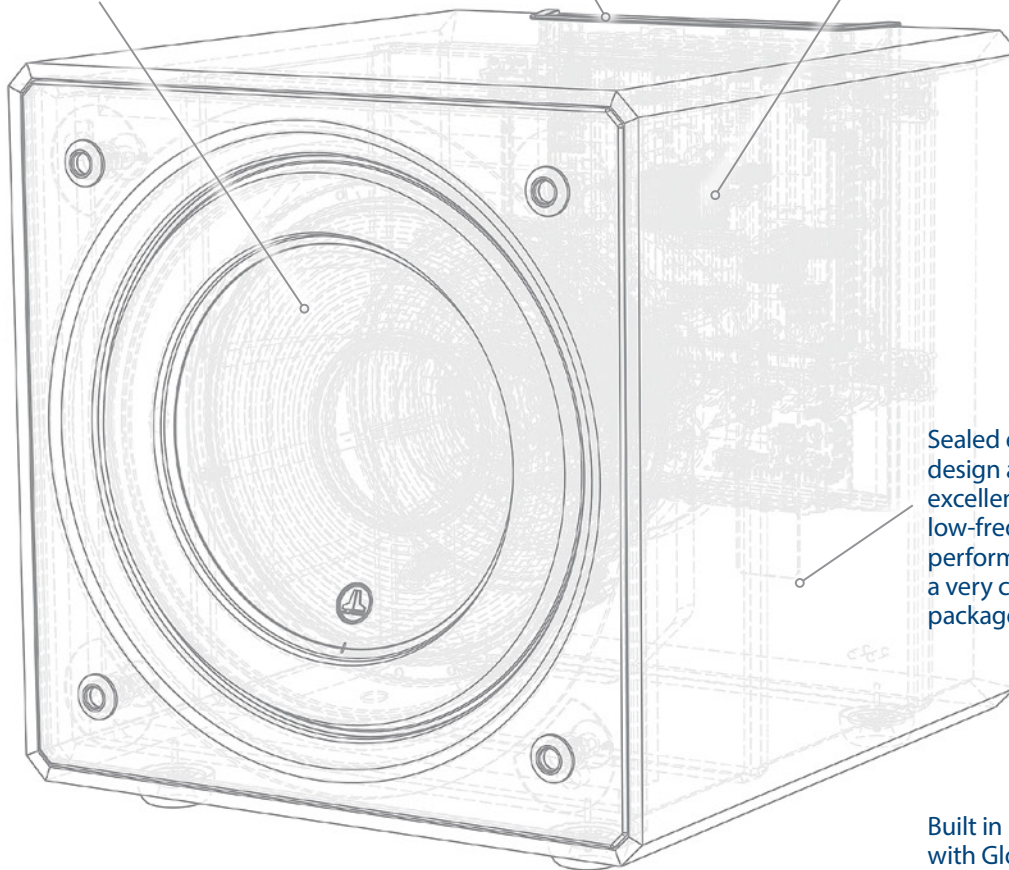

Sealed enclosure design achieves excellent low-frequency performance in a very compact package.

Built in USA with Global Components

Choose our spectacular gloss-black finish, or opt for the understated black ash veneer finish.

Net Weight: 73.5 lbs. (33.3 kg)

GAME-CHANGER



DOMINION®

“The d110s surprised me with their exploding-bomb bass. The room filled with energy, and I could feel the explosions through the subfloor due to the kinetic energy from the dual subwoofers. Solid performance, indeed.”

– David Vaughn, [Sound&Vision](#)







BUILT IN USA
WITH GLOBAL COMPONENTS

DOMINION®

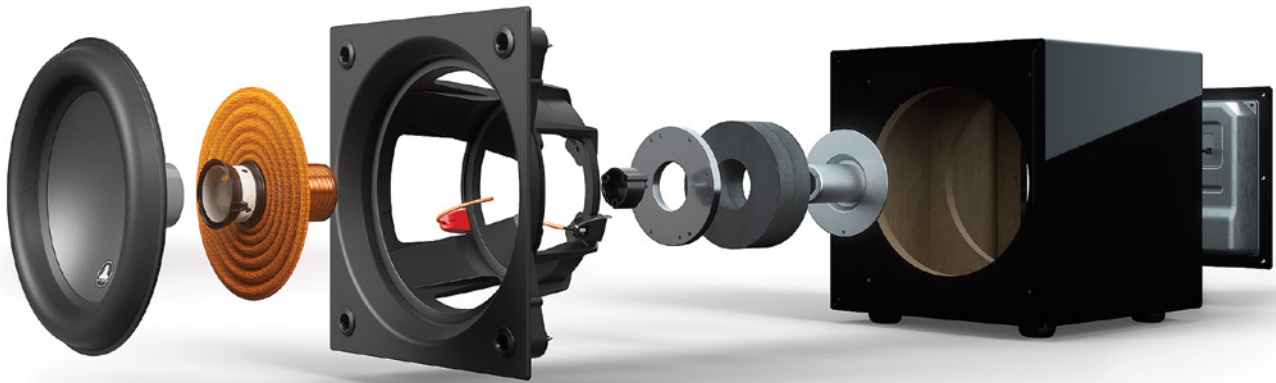

A purpose-engineered, long excursion driver, built on JL Audio's exclusive DMA motor optimization technology, lies at the heart of the Dominion® design. The DMA design leads to reduced distortion at higher output levels, as well as improved dynamic tracking and resolution. Dominion® drivers incorporate the front baffle into the driver itself and keep everything aligned properly with a massive cast-alloy frame.

Mighty.

The Dominion® powered subwoofers benefit from JL Audio's expertise in driver and amplifier design to arrive at a unique solution for applications requiring a compact, more affordable subwoofer.

Dominion® powered subwoofers can be used in full home theater systems, media room systems, dedicated two-channel music systems, desktop audio workstations, and small recording studios, just to name a few potential applications. High-level inputs even make it possible to add a subwoofer to systems lacking line outputs.



Every Dominion® powered subwoofer is precision-built, with global components, and fully tested in JL Audio's U.S. factory, to deliver years of listening enjoyment in your home audio or home theater system.



Controls are located on the rear of the unit. These include a variable low-pass filter, master level, variable phase, and switchable polarity.



The Dominion® amplifier is purpose-engineered, featuring an advanced Class D switching design, with a tightly-regulated switching power supply (a rarity in this price class). These technologies ensure that the Dominion® powered subwoofer remains in its comfort zone, well past the point where most small subwoofers run out of power or driver capability.

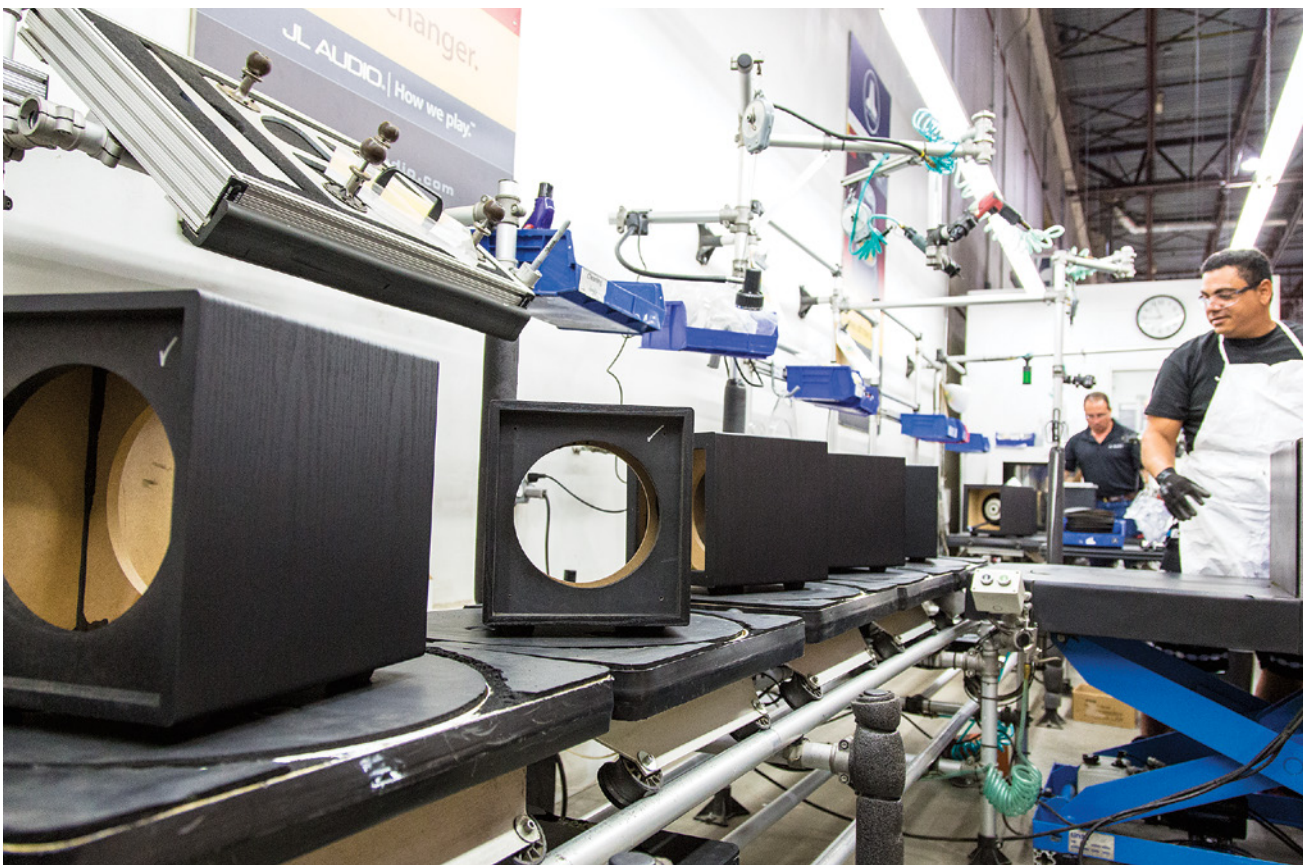
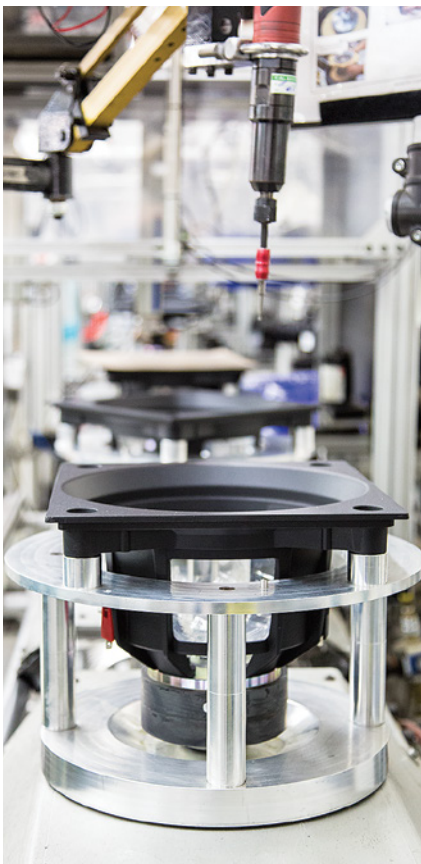

Dominion® Manufacturing

Our Miramar factory builds all of our home subwoofers, including our affordable Dominion® models. Their unique drivers are built using the same advanced equipment and processes reserved for our top models and they share a production line with the E-Sub™ lineup.



Dominion[®] d110 Subwoofer

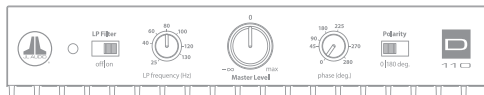

All controls and connections are on the rear panel.

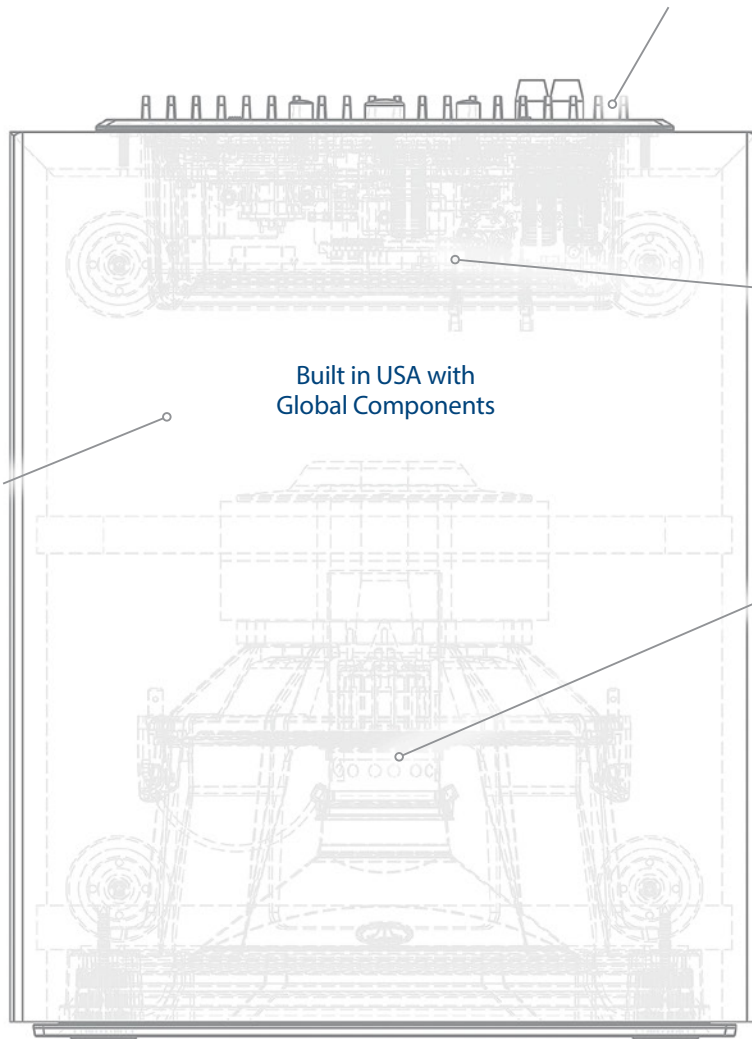

Sealed enclosure design achieves excellent low-frequency performance in a very compact package.

Built in USA with Global Components

Proprietary 750 Watt switching amplifier with integrated signal processing.

Specifically engineered, long-excursion subwoofer driver with cast alloy frame and steel baffle plate.

Net Weight: 38.2 lbs. (17.3 kg)

Choose our spectacular gloss-black finish or opt for the understated black ash veneer finish.

MIGHTY



Architectural Subwoofer Systems

Outstanding subwoofer systems, designed to disappear inside your walls or ceilings, and engineered to deliver the full JL Audio subwoofer experience.

Each IWS system is powered by a separate, rack-mountable amplifier with powerful digital signal processing features. These include JL Audio's exclusive D.A.R.O. technology.





IWSv2-SYS-113
Single 13.5-inch (345 mm)
In-Wall Subwoofer System
with Outboard Amplifier

The IWSv2-SYS-113 is
available to fit 2 x 4
or 2 x 6 wall studs.

D.A.R.O. calibration
microphone is included



IWSv2-SYS-213
Dual 13.5-inch (345 mm)
In-Wall Subwoofer System
with Outboard Amplifier

The IWSv2-SYS-213 is
available to fit 2 x 4
or 2 x 6 wall studs.

D.A.R.O. calibration
microphone is included



IWS-SYS-108
Single 8-inch (200 mm)
In-Wall Subwoofer System
with Outboard Amplifier

The IWS-108 System fits
2 x 4 wall studs or larger.

D.A.R.O. calibration
microphone sold separately



IWS-SYS-208
Dual 8-inch (200 mm)
In-Wall Subwoofer System
with Outboard Amplifier

The IWS-208 System fits
2 x 4 wall studs or larger.

D.A.R.O. calibration
microphone sold separately



ICS-SYS-108
Single 8-inch (200 mm)
In-Ceiling Subwoofer
System with Outboard
Amplifier

The ICS-108 System fits
2 x 6 ceiling joists or larger,
with assembled widths
ranging from 16-inches to
25 1/2-inches on center.

D.A.R.O. calibration
microphone sold separately



ICS-SYS-208
Dual 8-inch (200 mm)
In-Ceiling Subwoofer
System with Outboard
Amplifier

The ICS-208 System fits
2 x 6 ceiling joists or larger,
with assembled widths
ranging from 16-inches to
25 1/2-inches on center.

D.A.R.O. calibration
microphone sold separately

"The overall performance of the JL ICS is impressive on every level. It provides powerful bass response, great musicality, and can rock the house when necessary."

- Tone Audio: [The Audiophile Apartment](#)

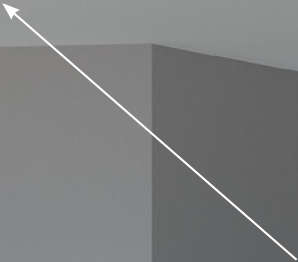
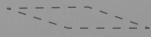

Versatility

Great audio is not just for media rooms. Our IWS and ICS systems make amazing sound a reality in any home environment.

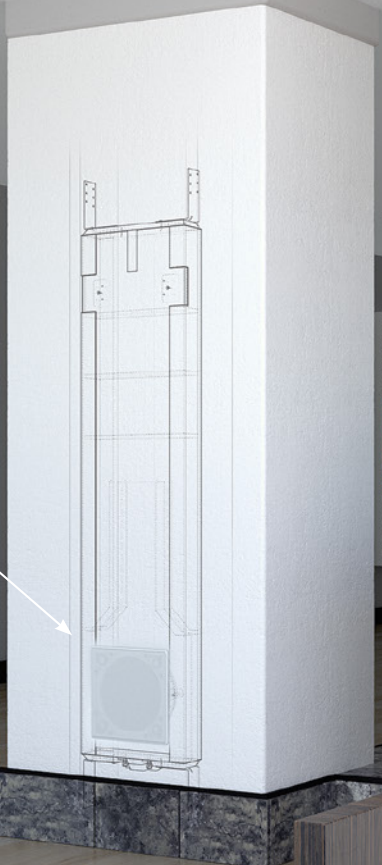



Architectural Subwoofer Systems

Unseen.

8-inch Fathom® IWS

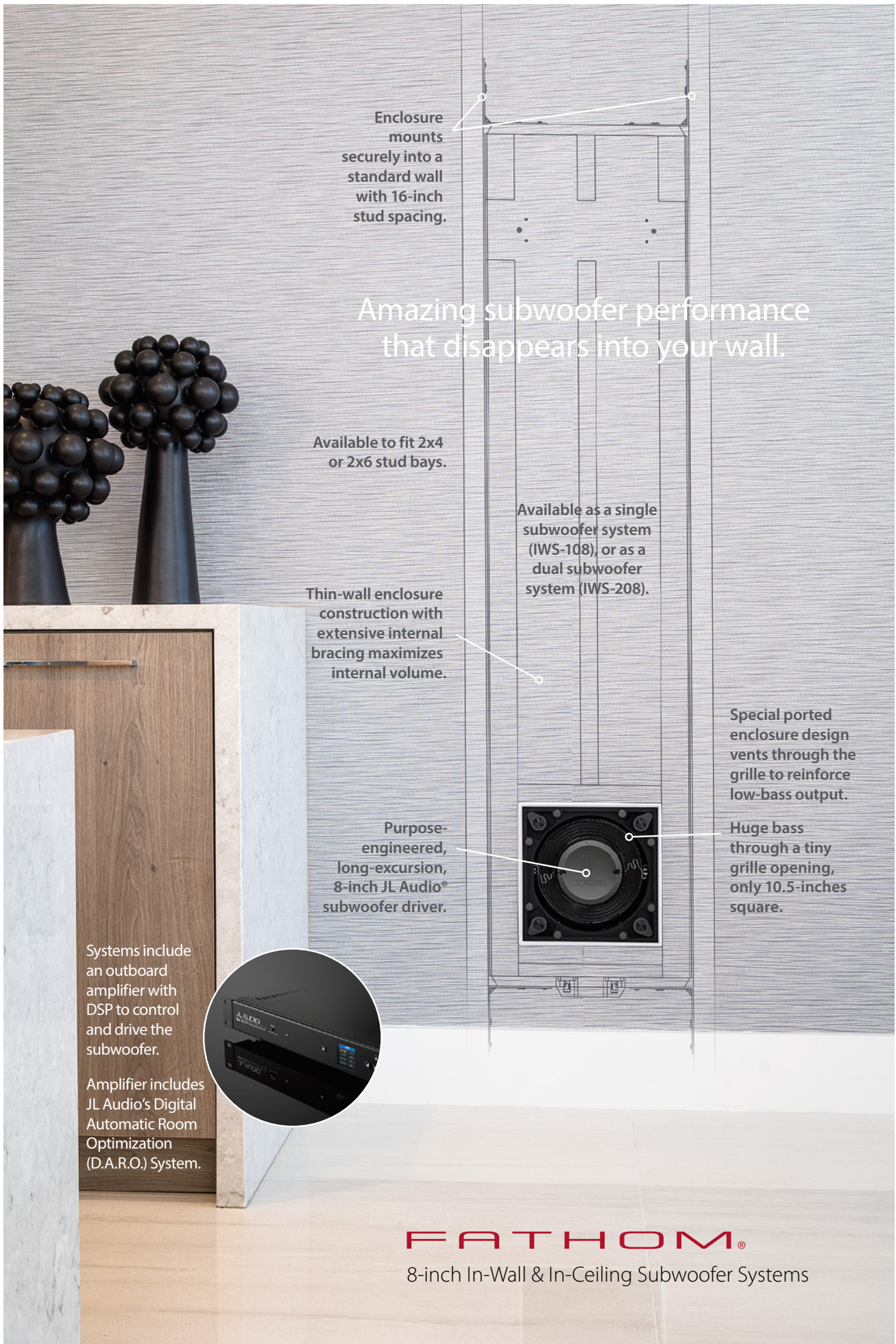

Enclosure mounts securely into a standard wall with 16-inch stud spacing.

Amazing subwoofer performance that disappears into your wall.

Available to fit 2x4 or 2x6 stud bays.

Available as a single subwoofer system (IWS-108), or as a dual subwoofer system (IWS-208).

Thin-wall enclosure construction with extensive internal bracing maximizes internal volume.

Special ported enclosure design vents through the grille to reinforce low-bass output.

Purpose-engineered, long-excursion, 8-inch JL Audio® subwoofer driver.

Huge bass through a tiny grille opening, only 10.5-inches square.

Systems include an outboard amplifier with DSP to control and drive the subwoofer.

Amplifier includes JL Audio's Digital Automatic Room Optimization (D.A.R.O.) System.



FATHOM®

8-inch In-Wall & In-Ceiling Subwoofer Systems

ICS-108
In-Ceiling
enclosure



A look inside of the IWS/ICS enclosures reveals there is much more than meets the eye on the outside. Each enclosure benefits from architectural features aimed at improving rigidity, while keeping a very low profile and minimal wall thickness to maximize enclosure volume. A unique port design vents through a slot located at the perimeter of the driver mount, enhancing efficiency and low-bass output.

8-inch IWS / ICS

Born from the same groundbreaking technologies used to develop our free-standing, powered subwoofers, Fathom® In-Wall and In-Ceiling subwoofer systems deliver remarkable bass performance, while remaining visually unobtrusive in any home environment.

The IWS in-wall enclosures are easy to integrate, fitting in standard 16-inch, on-center 2 x 4 stud bays, while the ICS in-ceiling variants are designed to fit 2 x 6 or larger ceiling joists, ranging from 16 to 25.5-inches, on-center. Both models fire through small discreet grilles, accommodating all common drywall thicknesses. The grilles are easily painted to match a room's decor and feature magnetically attached steel mesh inserts.



Our Thin-Line 8-inch Subwoofer

An engineering marvel with a unique motor and suspension design that extracts every millimeter of excursion possible from its slim mounting depth. It didn't exist, so we designed and built it.



Each 8-inch Fathom® IWS/ICS system is driven by a slim, rack-mountable (1U) amplifier with up to 600 watts of clean power, programmed specifically for each system. The complete set of Fathom® signal processing features is onboard, including our powerful, 18-band Digital Automatic Room Optimization (D.A.R.O.) system and high-pass crossover outputs, all accessible via an easy-to-use, menu-driven interface and LCD display.



IWS-108
In-Wall enclosure



The SA-600W Amplifier
is included with each subwoofer system.



Architectural Subwoofer Systems

13.5-inch Fathom® IWSv2

Disappears.

"If you want uncompromised bass performance in a room that won't easily accommodate freestanding subwoofers, there's only one game in town."

— Robert Harley - [The Absolute Sound](#)



FATHOM® IWS
IN-WALL SUBWOOFER SYSTEMS

The grille frames and mesh of the IWS systems are white, with a paintable finish, lending themselves to being custom-finished to match the wall decor (as shown here).



"It's a sub that makes no
acoustic compromises..."

— Darryl Wilkinson - Sound&Vision



13.5-inch IWSv2

The same minds that engineered JL Audio's reference-grade Fathom® and Gotham® powered subwoofers have created an amazing, high power in-wall subwoofer solution, centered on a groundbreaking, 13.5-inch, thin-line subwoofer driver.

There is no need to lower your expectations when selecting this remarkable in-wall solution... it's a real Fathom®, at home in the most demanding home theater or music system applications.



Each IWSv2 system is driven by purpose-tuned amplifier, capable of delivering up to 2 kW of clean power. JL Audio's powerful DSP engine is also on-hand, including our exclusive Digital Automatic Room Optimization (D.A.R.O.) system to ensure a smooth response, even in challenging rooms. Amplifier includes removable rack-mounting brackets.

IWSv2-SYS-113
Sealed enclosure with one (1) 13.5" diameter subwoofer driver and 1000W amplifier/processor



Housing this exotic driver, is a critically engineered enclosure with a patented, floating mount design to minimize wall excitation (a pretty major concern, considering the output of this system). The enclosure utilizes extensive architectural features aimed at improving rigidity while keeping a very low profile and minimal wall thickness. IWSv2 systems are available with single or dual subwoofer enclosures, to fit 2 x 4 or 2 x 6 stud bays.

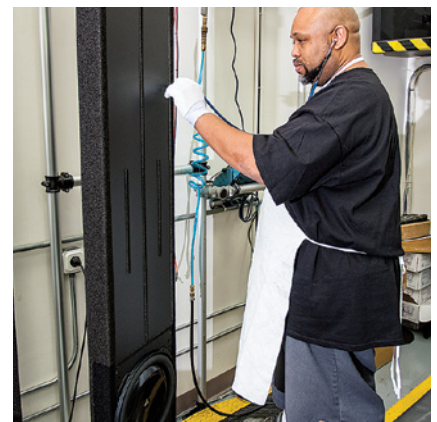
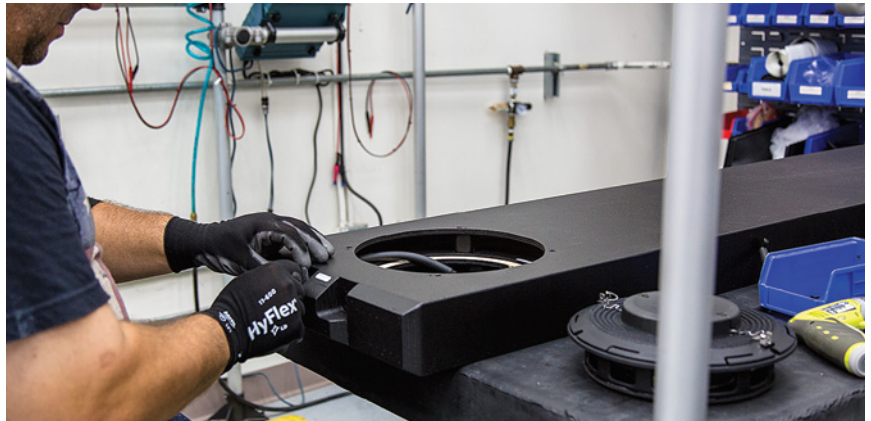
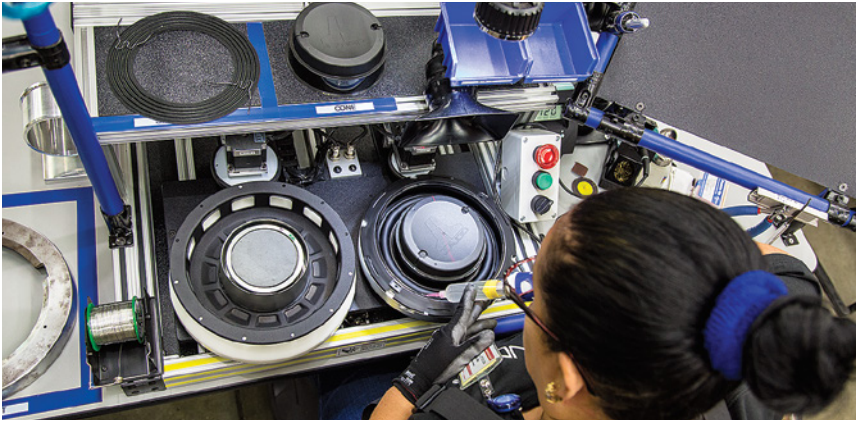
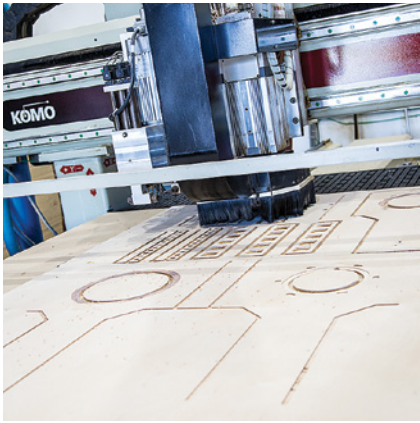

Fathom® IWS Manufacturing

The simple exteriors of our in-wall subwoofer enclosures conceal the intricacies of their design, which require many hours of skilled woodworking to build. Thin, marine grade, birch plywood is the material of choice to maximize internal air space in the tight space available between wall studs. Subwoofer enclosures must be very rigid to achieve great bass performance, not an easy feat when an enclosure is long and thin. We engineer each IWS enclosure to incorporate an intricate web of internal braces, consisting of many CNC-machined parts. These are assembled with extreme attention to detail by a small team of highly skilled craftsmen. Their work is tested at the end of the process by installing a driver, powering the system and testing the enclosure with a stethoscope, ensuring there are no wayward resonances.



Fully suspended, floating mounting system allows for powerful bass output without vibrating the walls.

U.S. Patent #: 8,605,936

Fathom® IWSv2 Subwoofer

Amazing, high-power subwoofer performance that disappears into your wall.

Available as a single subwoofer system (IWSv2-SYS-113), or as a dual subwoofer system (IWSv2-SYS-213).

Thin-wall enclosure construction with extensive internal bracing maximizes internal volume.

Available to fit 2x4 or 2x6 stud bays.

Special suspension design couples the grille opening to the enclosure, creating a seal and preventing wall rattling.

Purpose-engineered, long-excursion, 13.5-inch JL Audio subwoofer driver



Systems include an outboard amplifier with DSP to control and drive the subwoofer.

1000 W with single subwoofer, or 2000 W with dual subwoofer system

Amplifier includes JL Audio's Digital Automatic Room Optimization (D.A.R.O.) System.

Huge bass through a discreet grille opening, less than 18 inches square.

CR-1: Active Subwoofer Crossover



The perfect blend.

CR-1 is the ultimate tool for subwoofer integration.



The CR-1 Active Subwoofer Crossover has been designed by audiophiles, for audiophiles. We believe it has no equal, offering a powerful combination of subwoofer/satellite tuning features, and a complete commitment to analog signal purity.

When properly set up, CR-1 creates a listening experience in which the subwoofers and main speakers become one, delivering a cohesive and compelling sonic presentation that not only delivers supernaturally good sub-bass, but also vastly improved performance from your main speakers. They will simply open up, delivering improved dynamics, superior imaging, and more low-level detail. Many describe it as the greatest speaker upgrade they have ever made.

CR-1 is no garden-variety active crossover. It is built around two banks of precision Linkwitz-Riley low-pass and high-pass filters with 12 or 24 dB (selectable) slopes. Multiplying DACs with monolithic ratio matching are employed to adjust the analog circuit's filter frequencies. This offers superior tracking behavior and far more precise left/right channel balance, compared to conventional approaches.

Another of CR-1's unique and powerful features is a pair of rotary controls that control the damping of each filter bank. These damping controls dramatically improve the acoustic summing through the crossover region by compensating for each speaker system's frequency response. At the center of the front panel, a single, intuitive rotary control permits quick adjustment of the relative level between the subwoofer(s) and main speakers.

To minimize distortion and noise, CR-1 employs top-grade component parts in its all-analog audio circuitry: 1% precision resistors, JFET-input audio-grade op-amps, polypropylene film-and-foil capacitors and metallized-polypropylene film capacitors, to name just a few.

CR-1's input-output design makes it equally adaptable to studio, mastering suite or audiophile stereo playback environments. To accommodate dual-mode systems, we also include a bypass feature that engages a pass-through from a dedicated "Managed Bass Input" on the rear panel to the CR-1's subwoofer outputs. This makes it convenient to quickly switch from stereo to multi-channel mode in a room where the subwoofers are shared between a stereo system and a multi-channel system.

JLINK™ TRX / RX



Wireless cables?

The JLINK™ wireless audio system is designed for all those situations where running audio signal cables is impractical, but audio quality cannot be compromised.

The JLINK™ TRX kit connects any two line-level audio devices together via a bit-perfect, wireless protocol that retains the full fidelity of your audio signals, without the compression of lossy wireless systems.

If you wish to expand your JLINK™ setup, up to four JLINK™ RX receivers can be connected to a single JLINK™ transmitter, delivering audio signals to multiple points in your home. Up to three JLINK™ transmitters can operate in a home, each on its own wireless channel, and each connected to up to four JLINK™ RX receivers.

- Bit-Perfect Digital PCM Stereo Wireless Technology (16 bit / 48 kHz)
- Indoor range up to 100 feet (30 meters)
- Outstanding fidelity in subwoofer or full-range applications
- RCA-type input/output connectors are compatible with most audio equipment
- Receivers include JLINK™ direct connection port for use with compatible JL Audio products

Ideal for wireless connection of subwoofers or full-range systems.



The JLINK™ Transmitter connects to your audio system via a pair of analog inputs with RCA-type jacks.



The JLINK™ Receiver offers analog outputs via RCA-type jacks or a direct, powered connection to the JLINK™ port on a compatible JL Audio subwoofer.



A switch on the underside of each JLINK™ unit assigns it to one of three RF channels, allowing multiple JLINK™ systems to operate independently in a home.

Features: In-Room Powered Subwoofers

	Gotham® g213v2	Fathom® f212v2	Fathom® f113v2	Fathom® f112v2	Fathom® f110v2
Unbalanced Inputs:	Stereo or Mono (two RCA jacks)	Stereo or Mono (two RCA jacks)			
Balanced Inputs:	Stereo or Mono (two female XLR jacks)	Stereo or Mono (two female XLR jacks)			
Output To Slave:	Balanced (one male XLR jack)	Balanced (one male XLR jack)			
Input Modes:	Master or Slave	Master or Slave			
Input Grounding:	Isolated or Grounded	Isolated or Grounded			
Level Control Modes:	Reference (fixed gain) or Variable from full mute to +15 dB over reference gain	Reference (fixed gain) or Variable from full mute to +15 dB over reference gain			
Power Modes:	Off, On or Automatic Signal-Sensing	Off, On or Automatic Signal-Sensing			
Light Modes:	Off, On or Dim	Off, On or Dim			
Crossover Type / Mode:	Low-Pass / Off, 12 dB per octave or 24 dB per octave	Low-Pass / Off, 12 dB per octave or 24 dB per octave			
Crossover Frequency Range:	Variable from 30 Hz – 130 Hz	Variable from 30 Hz – 130 Hz			
Polarity:	0 or 180 degrees	0 or 180 degrees			
Phase:	Variable from 0 – 270 degrees	Variable from 0 – 280 degrees, referenced to 80 Hz			
E.L.F. Trim:	Variable from -12 dB to +3 dB at 25 Hz	Variable from -12 dB to +3 dB at 25 Hz			
Digital Automatic Room Optimization (D.A.R.O.):	18-band, 1/6 octave automatic equalizer (defeatable). Includes laboratory-grade calibration microphone.				

	E-Sub™ e112	E-Sub™ e110	Dominion® d110	Dominion® d108
Unbalanced Inputs:	Stereo or Mono (two RCA jacks)		Stereo or Mono (two RCA jacks) or direct JLink™ connection	
High-Level Inputs:	Stereo or Mono (removable plug)		Stereo or Mono (removable plug)	
Line Outputs:	Unbalanced (two RCA jacks): High-Pass (set by crossover) or Pass-Through		N/A	
Input Grounding:	Selectable (Isolated or Grounded)		Isolated or Grounded	
Level Control Mode:	Variable: full mute to +15 dB over reference gain		Variable: full mute to +15 dB over reference gain	
Power Modes:	Off, On or Automatic Signal-Sensing		Automatic Signal-Sensing only	
Crossover Type:	Low-Pass, with tracking High-Pass line outputs (True 2-Way)		Low-Pass	
Crossover Mode:	Off, 24 dB per octave with Linkwitz-Riley alignment		Off, 24 dB per octave with Linkwitz-Riley alignment	
Crossover Frequency Range:	Variable from 25 Hz – 130 Hz		Variable from 25 Hz – 130 Hz	
Polarity:	0 or 180 degrees		0 or 180 degrees	
Phase:	Variable from 0 – 280 degrees, referenced to 80 Hz		Variable from 0 – 280 degrees, referenced to 80 Hz	

Features: In-Wall & In-Ceiling Subwoofer Systems

	Fathom® IWSv2-SYS-113 / 213	Fathom® IWS-SYS-108 / 208	Fathom® ICS-SYS-108 / 208
Unbalanced Inputs:	Stereo or Mono (two RCA jacks)	Stereo or Mono (two RCA jacks)	
Balanced Inputs:	Stereo or Mono (two female XLR jacks)	N/A	
High-Level Inputs:	N/A	Stereo or Mono (removable plug)	
Speaker Outputs:	Neutrik speak-On® 2-Pole Connectors (uses Neutrik part: NL2FX, included)	Neutrik speak-On® 2-Pole Connectors (uses Neutrik part: NL2FX, included)	
Line Outputs:	N/A	Stereo or Mono (two RCA jacks - Pass-Through or High-Pass)	
Output To Slave:	Balanced (one male XLR jack)	N/A	
Input Modes:	Master or Slave	N/A	
Input Grounding:	N/A	Isolated or Grounded	
Level Control Modes:	Reference (fixed gain) or Variable from full mute to +15 dB over reference gain	Reference (fixed gain) or Variable from -50 dB to +15 dB over reference gain (0.5 dB increments)	
Power Modes:	Off, On or Automatic (Signal-Sensing or 12V Trigger)	Off, On, Automatic (Signal-Sensing or 12V Trigger)	
Light Modes:	Off, On or Dim	N/A	
Crossover Type:	Low-Pass	Low-Pass, with tracking High-Pass line outputs (True 2-Way)	
Crossover Mode:	Off, 12 dB per octave or 24 dB per octave	Off, 12 dB per octave or 24 dB per octave (Low-Pass, with tracking High-Pass Outputs)	
Crossover Frequency Range:	Variable from 30 Hz – 130 Hz	Variable from 30 Hz – 130.1 Hz	
Polarity:	0 or 180 degrees	0 or 180 degrees	
Phase:	Variable from 0 – 270 degrees, referenced to 80 Hz	N/A	
Delay:	N/A	Variable from 0 – 25 ms (0.1 ms increments, Sub and HP outputs)	
E.L.F. Trim:	Variable from -12 dB to +3 dB at 23 Hz	Variable from -12 dB to +3 dB at 25 Hz (0.5 dB increments)	
Equalizer / Frequency Range:	N/A	3 bands / 20 Hz to 160 Hz (1 Hz increments)	
Equalizer Gain Range:	N/A	-12 dB to +12 dB (0.2 dB increments)	
Equalizer Q Range:	N/A	0.7 to 5.0 (0.1 increments)	
Controls:	Front Panel	D-Pad navigation buttons with LCD display	
Digital Automatic Room Optimization (D.A.R.O.):	18-band, 1/6 octave automatic equalizer (defeatable). Includes laboratory-grade calibration microphone.	18-band, 1/6 octave automatic equalizer (defeatable). Calibration microphone is sold separately.	
12V Trigger Output Capacity:	150 mA (1/8-inch/3.5mm mini jack)	150 mA (1/8-inch/3.5mm mini jack)	
Wireless Connectivity:	Optional, JLINK™ TRX System (sold separately)	Optional, JLINK™ TRX System (sold separately)	

Specifications: In-Room Powered Subwoofers

	Gotham® g213v2	Fathom® f212v2	Fathom® f113v2	Fathom® f112v2	Fathom® f110v2
Enclosure Type:	Sealed, with curved, non-parallel walls	Sealed			
Driver(s):	Dual 13.5-inch (nominal diameter)	Dual 12-inch (nominal diameter)	Single 13.5-inch (nominal diameter)	Single 12-inch (nominal diameter)	Single 10-inch (nominal diameter)
Frequency Response (anechoic):	19 – 112 Hz (±1.5dB) -3 dB at 17.5 Hz / 120 Hz -10 dB at 14 Hz / 150 Hz	20 – 97 Hz (1.5dB) -3 dB at 19 Hz / 110 Hz -10 dB at 15 Hz / 157 Hz	20 – 86 Hz (±1.5dB) -3 dB at 18 Hz / 127 Hz -10 dB at 16 Hz / 154 Hz	21 – 119 Hz (±1.5dB) -3 dB at 19 Hz / 150 Hz -10 dB at 17 Hz / 167 Hz	27 – 111 Hz (±1.5dB) -3 dB at 25 Hz / 120 Hz -10 dB at 19 Hz / 155 Hz
Effective Piston Area:	214.70 sq. in. 0.1386 sq. m	168 sq. in. 0.1084 sq. m	107.35 sq. in. 0.0693 sq. m	84 sq. in. 0.0542 sq. m	60 sq. in. 0.0387 sq. m
Effective Displacement:	773 cu. in. 12.7 liters	574 cu. in. 9.4 liters	386 cu. in. 6.3 liters	287 cu. in. 4.7 liters	160 cu. in. 2.6 liters
Amplifier Power:	4500 watts RMS short-term	3600 watts RMS short-term	3000 watts RMS short-term	1800 watts RMS short-term	1100 watts RMS short-term
Dimensions*: (H) Height x (W) Width x (D) Depth	34.13 in. x 21.50 in. x 24.00 in. 867 mm x 546 mm x 610 mm	31.96 in. x 14.92 in. x 20.39 in. 812 mm x 379 mm x 518 mm	19.625 in. x 16.50 in. x 19.25 in. 498 mm x 419 mm x 489 mm	18.50 in. x 15.00 in. x 17.625 in. 470 mm x 381 mm x 448 mm	15.64 in. x 12.92 in. x 17.27 in. 397 mm x 328 mm x 439 mm
Net Weight:	360 lbs. 163 kg	224 lbs. 102 kg	133 lbs. 60 kg	117 lbs. 53 kg	69 lbs. 31 kg
Cabinet Finish:	High-Gloss Black				
Built in USA, with Global Components					

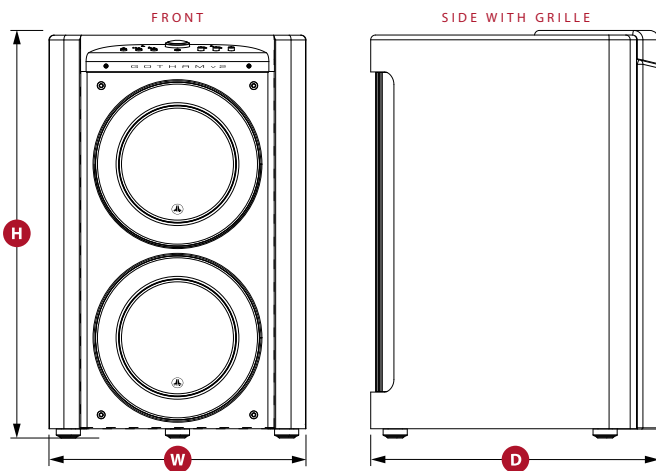

* All height dimensions include feet; depth dimensions include grilles.

Gotham®

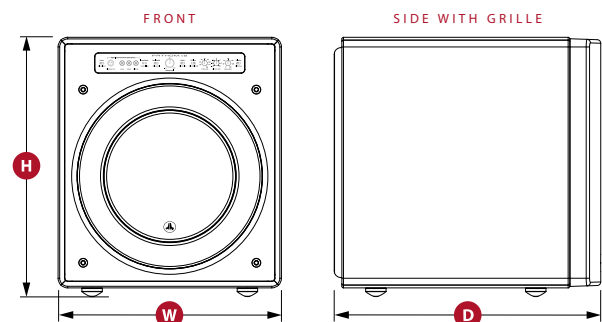
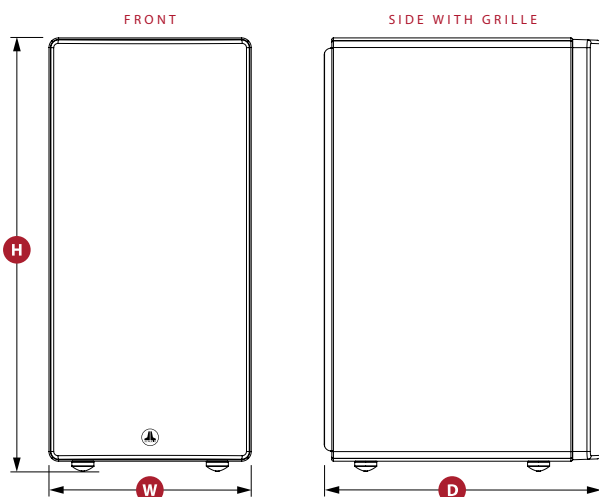

Fathom®

	E-Sub™ e112	E-Sub™ e110	Dominion® d110	Dominion® d108
Enclosure Type:	Sealed			
Driver(s):	Single 12-inch (nominal diameter)	Single 10-inch (nominal diameter)	Single 10-inch (nominal diameter)	Single 8-inch (nominal diameter)
Frequency Response (anechoic):	22 – 118 Hz (±1.5dB) –3 dB at 21 Hz / 120 Hz –10 dB at 17 Hz / 153 Hz	25 – 116 Hz (±1.5dB) –3 dB at 23 Hz / 120 Hz –10 dB at 18 Hz / 165 Hz	27 – 111 Hz (±1.5dB) –3 dB at 25 Hz / 118 Hz –10 dB at 21 Hz / 143 Hz	31 – 112 Hz (±1.5dB) –3 dB at 29 Hz / 119 Hz –10 dB at 21 Hz / 143 Hz
Effective Piston Area:	84.40 sq. in. 0.0545 sq. m	58.78 sq. in. 0.0379 sq. m	48.71 sq. in. 0.0314 sq. m	32.18 sq. in. 0.0208 sq. m
Effective Displacement:	235 cu. in. 3.9 liters	131 cu. in. 2.1 liters	127 cu. in. 2.08 liters	80 cu. in. 1.3 liters
Amplifier Power:	1500 watts RMS short-term	1200 watts RMS short-term	750 watts RMS short-term	500 watts RMS short-term
Dimensions*: (H) Height x (W) Width x (D) Depth	16.23 in. x 15.50 in. x 18.39 in. 412 mm x 394 mm x 467 mm	14.24 in. x 13.50 in. x 16.51 in. 362 mm x 343 mm x 419 mm	13.40 in. x 12.00 in. x 15.86 in. 340 mm x 305 mm x 403 mm	11.37 in. x 10.00 in. x 13.23 in. 289 mm x 254 mm x 336 mm
Net Weight:	73.5 lbs. 33.3 kg	52.7 lbs. 23.9 kg	38.2 lbs. 17.3 kg	26.4 lbs. 12 kg
Cabinet Finish:	High-Gloss Black or Black Ash Vinyl Veneer		High-Gloss Black or Black Ash Vinyl Veneer	
Built in USA, with Global Components				

* All height dimensions include feet; depth dimensions include grilles.

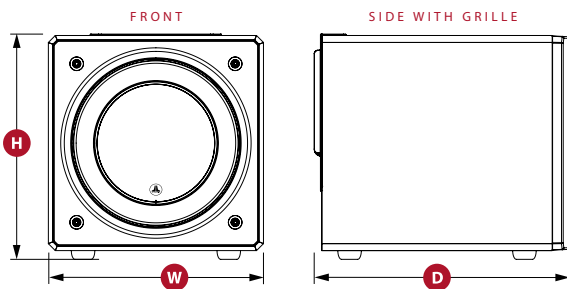

E-Sub™

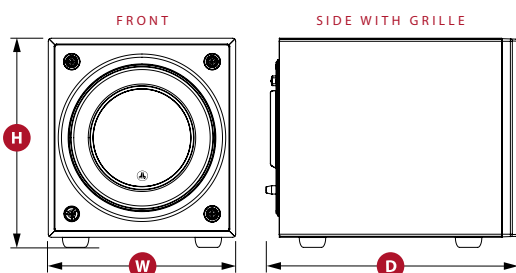

Dominion®

Specifications: In-Wall & In-Ceiling Subwoofer Systems

	Fathom® IWSv2-SYS-113	Fathom® IWSv2-SYS-213	Fathom® IWS-SYS-108	Fathom® IWS-SYS-208	Fathom® ICS-SYS-108	Fathom® ICS-SYS-208
Enclosure Type:	Single Sealed Enclosure	Two Sealed Enclosures	Single Ported Enclosure	Two Ported Enclosures	Single Ported Enclosure	Two Ported Enclosures
Driver(s):	13.5-inch (nominal diameter)	13.5-inch (nominal diameter) in each of two enclosures	8-inch (nominal diameter)	8-inch (nominal diameter) in each of two enclosures	8-inch (nominal diameter)	8-inch (nominal diameter) in each of two enclosures
Frequency Response (anechoic):	26 Hz - 101 Hz (+/- 1.5 dB) -3dB at 25 Hz / 112 Hz -10dB at 22 Hz / 150 Hz		24.9 Hz - 109 Hz (+/- 1.5 dB) -3dB at 24.6 Hz / 111 Hz -10dB at 23.4 Hz / 118 Hz		24.9 Hz - 109 Hz (+/- 1.5 dB) -3dB at 24.6 Hz / 111 Hz -10dB at 23.4 Hz / 118 Hz	
Effective Piston Area:	98.26 sq. in. 0.0634 sq. m	196.51 sq. in. 0.1268 sq. m	31.62 sq. in. 0.0204 sq. m	63.24 sq. in. 0.0408 sq. m	31.62 sq. in. 0.0204 sq. m	63.24 sq. in. 0.0408 sq. m
Effective Displacement:	147.30 cu. in. 2.41 liters	294.60 cu. in. 4.82 liters	47.50 cu. in. 0.78 liters	95.00 cu. in. 1.56 liters	47.50 cu. in. 0.78 liters	95.00 cu. in. 1.56 liters
2 x 4 Enclosure Dimensions: (H) Height x (W) Width x (D) Depth Measurements do not include padding material.	70.00 in. x 13.75 in. x 2.90 in. 1,778 mm x 349 mm x 74 mm		61.63 in. x 14.00 in. x 3.25 in. 1,565 mm x 355 mm x 83 mm		N/A	
2 x 6 Enclosure Dimensions: (H) Height x (W) Width x (D) Depth Measurements do not include padding material.	55.00 in. x 13.75 in. x 4.70 in. 1,397 mm x 349 mm x 119 mm		N/A		40.71 in. x 14.00 in. x 5.13 in. 1,034 mm x 355 mm x 130 mm	
Stud / Joist Width Fitment:	16 inches on center		16 inches on center		16 inches to 25.50 inches on center	
Enclosure Finish:	Black Texture-Coated		Black Texture-Coated		Black Texture-Coated	
Amplifier Power:	1000 watts RMS short-term	2000 watts RMS short-term	300 watts RMS short-term	600 watts RMS short-term	300 watts RMS short-term	600 watts RMS short-term
Amplifier Table-Top Dimensions: (H) Height x (W) Width x (D) Depth Height Dimensions DO NOT include feet.	3.50 in. x 17.4 in. x 17.90 in. 89 mm x 442 mm x 455 mm		1.75 in. x 16.84 in. x 13.63 in. 44 mm x 428 mm x 346 mm		1.75 in. x 16.84 in. x 13.63 in. 44 mm x 428 mm x 346 mm	
Amplifier Rack-Mount Dimensions: (H) Height x (W) Width x (D) Depth Height Dimensions DO NOT include feet.	3.50 in. x 19.00 in. x 17.90 in. 89 mm x 484 mm x 455 mm (2U)		1.75 in. x 19.0 in. x 13.63 in. 44 mm x 483 mm x 346 mm (1U)		1.75 in. x 19.00 in. x 13.63 in. 44 mm x 483 mm x 346 mm (1U)	
Amplifier Net Weight:	35 lbs. 15.9 kg	43 lbs. 19.5 kg	13.5 lbs. 6.12 kg		13.5 lbs. 6.12 kg	
Grille Dimensions: (H) Height x (W) Width	17.64 in. x 17.14 in. 448 mm x 435 mm		10.50 in. x 10.50 in. 267 mm x 267 mm		10.50 in. x 10.50 in. 267 mm x 267 mm	
Grille Opening Dimensions: (H) Height x (W) Width	16.00 in. x 16.50 in. 406 mm x 419 mm		9.75 in. x 9.75 in. 248 mm x 248 mm		9.75 in. x 9.75 in. 248 mm x 248 mm	
Grille Finish:	White (paintable)		White (paintable)		White (paintable)	
Built in USA, with Global Components:	Subwoofer Enclosure and Subwoofer Driver (Amplifier is imported.)					

Fathom® IWSv2-SYS-113/213

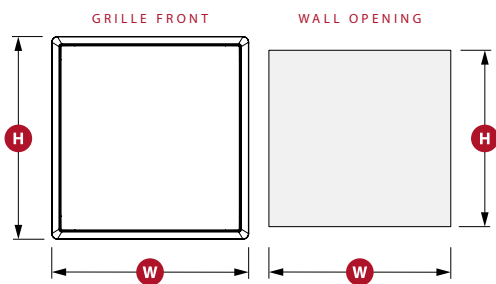
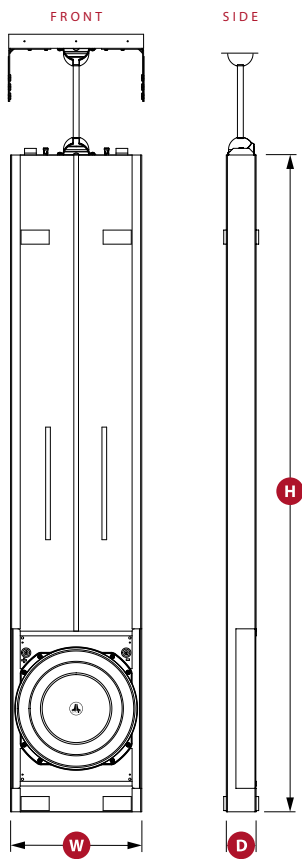
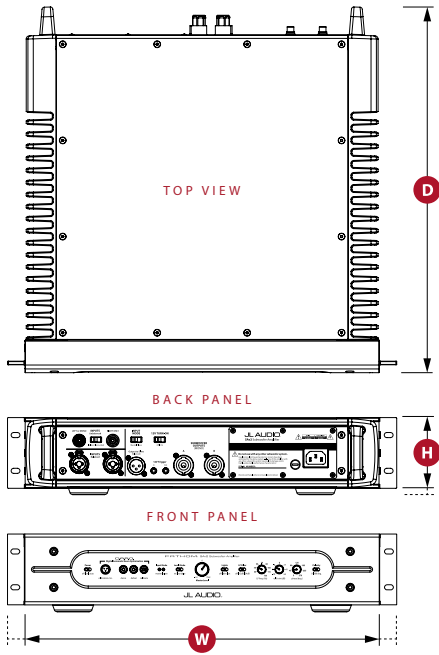

Fathom® IWS-SYS-108/208 & ICS-SYS-108/208

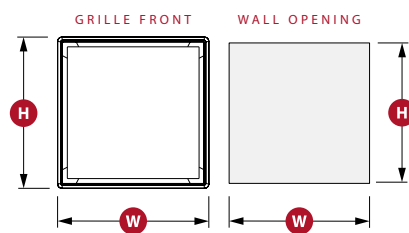
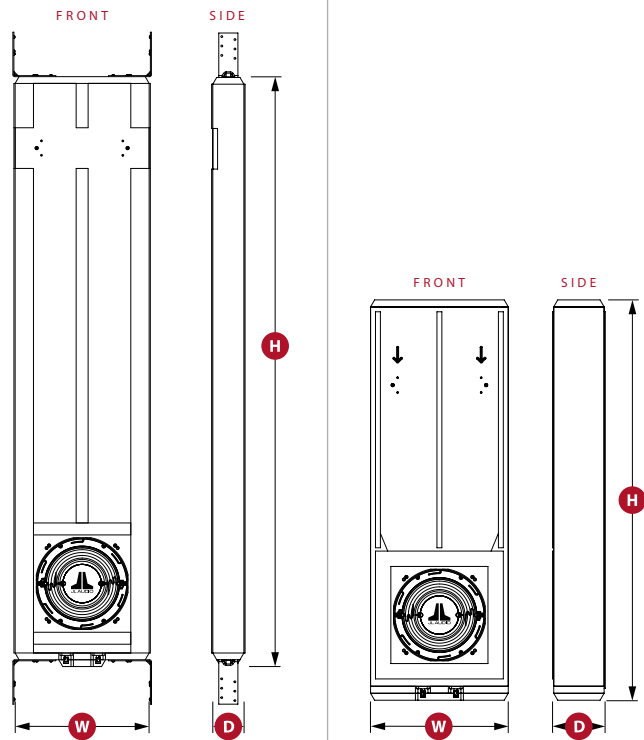
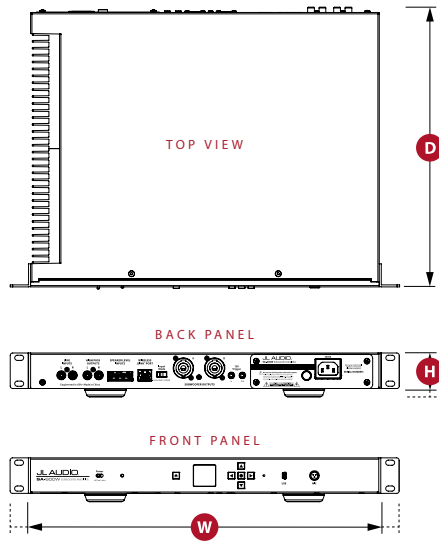

Features: CR-1

	CR-1
Main Stereo Inputs:	Unbalanced L/R: (2 RCA jacks) Balanced L/R (2 XLR/TRS combo jacks)
Managed Bass Inputs:	Unbalanced L/R: (2 RCA jacks) Balanced L/R (2 XLR/TRS combo jacks)
Satellite Line Outputs:	Unbalanced (2 RCA jacks) Balanced (2 TRS jacks, 2 XLR jacks)
Subwoofer Line Outputs:	Unbalanced L/R: (2 RCA jacks) Balanced L/R: (2 TRS jacks, 2 XLR jacks)
Power Modes:	Off/On, selectable via front panel switch
Subwoofer Output Modes:	Mono L+R or Stereo, selectable via front panel switch
Subwoofer/Satellite Balance Control:	+/- 12 dB, fully variable via front panel knob
Crossover Function:	Bypass or On, selectable via front panel switch
Crossover Frequency Range:	30 Hz – 150 Hz, variable with independent high-pass and low-pass filter frequency controls on front panel
Filter Damping Controls:	Q: 0.3 - 1.4 @ 12 dB/octave, via front panel knob Q: 0.16 - 4.0 @ 24 dB/octave, via front panel knob For either slope, Q = 0.5 at top dead center "0" mark
Crossover Slopes:	12 dB/octave or 24 dB/octave, Linkwitz-Riley selectable via front panel switch
Output Muting:	independent for each output, via front panel push-button switches
Ground Lift:	Isolated/Grounded, via rear panel switch

Specifications: CR-1

	CR-1
Maximum Input Voltage:	8 Vrms (+18 dBV)
Input Impedance:	Unbalanced: 50 k Ω Balanced: 20 k Ω (10 k Ω per leg)
Maximum Output Voltage:	8 Vrms (+18 dBV)
Output Impedance:	Unbalanced: 150 Ω Balanced: 300 Ω (150 Ω per leg)
THD + Noise:	< 0.002% at 8 Vrms/10 k Ω 20 Hz - 20 kHz, 90 kHz bandwidth
Channel Separation:	>80 dB at 1 kHz
Low Pass Frequency Response:	+0, -1 dB from 5 Hz to 1/4 of filter frequency
High Pass Frequency Response:	+0, -1 dB from 4x filter frequency to 80 kHz
Power Consumption:	30 Watts (typical, with or without signal)
Mains Voltage (Frequency):	120V (60 Hz) or 230/240V (50 Hz or 60 Hz), factory-set for destination country
Table-Top Dimensions: (H) Height x (W) Width x (D) Depth	3.80 in. x 17.40 in. x 15.67 in. 97 mm x 441 mm x 398 mm
Rack-Mount Dimensions: (H) Height x (W) Width x (D) Depth	3.46 in. x 19.07 in. x 15.67 in. 88 mm x 441 mm x 398 mm

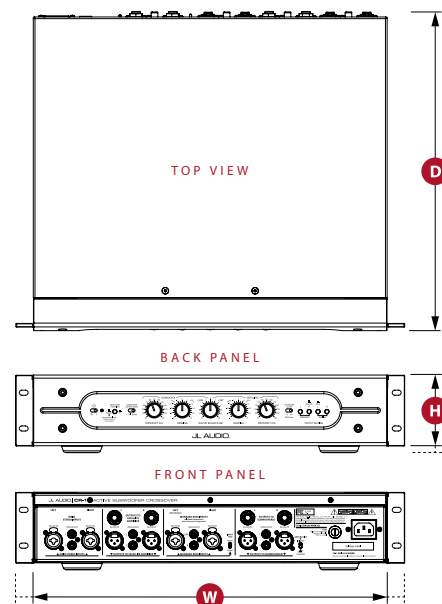

JLINK™: TRX Wireless System

	TRX Wireless System
S/N Ratio:	80 dB @ 1 kHz, 500 mV
THD + Noise:	0.02% @ 1 kHz, 500 mV
Crosstalk:	>75 dB @ 1 kHz, 500 mV
Frequency Response:	16 Hz – 22 kHz (+0, -1dB)
Wireless Range:	100 feet / 30 meters (typical)
Wireless Channels:	3 available, selectable via switch
Latency:	14 ms
Operating Temperature:	32 to 104 °F / 0 to 40 °C
AC Power Adaptor	1 A, 5 volts DC

JLINK™: TX Transmitter

	TX Transmitter
Inputs:	Analog, left and right RCA-type
Line Input Impedance:	25 kΩ
Outputs:	Bit-Perfect PCM Stereo Digital via 2.4 GHz Wireless
Bit Depth/Sample Rate:	16 Bit / 48 kHz
Connected receivers:	Up to 4
Power Requirements:	200 mA, 5 volts (via included AC adaptor)
Dimensions: (H) Height x (W) Width x (D) Depth	1.12 in. x 3.50 in. x 3.50 in. 28.5 mm x 89 mm x 89 mm

JLINK™: RX Receiver

	RX Receiver
Inputs:	Bit-Perfect PCM Stereo Digital via 2.4 GHz Wireless
Outputs:	Analog, left & right RCA-type, or via JLINK™ port to compatible product
Output Impedance:	250 Ω
Full Scale Line Output Voltage:	1.2 V
Power Requirements:	100 mA, 5 volts (via included AC adaptor or JLINK port)
Dimensions: (H) Height x (W) Width x (D) Depth	1.12 in. x 3.50 in. x 3.50 in. 28.5 mm x 89 mm x 89 mm

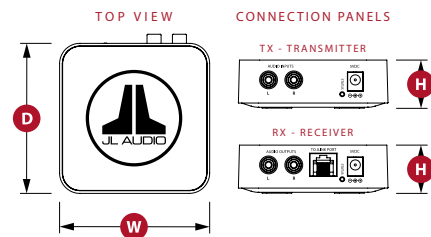

Engineered and built to perform like no other.

JL AUDIO® | **How we play.**®

All specifications are subject to change without notice. "Ahead of the Curve", "How we play", "Fathom", "Gotham", "Dominion", "JL Audio" and the JL Audio logo are registered trademarks of JL Audio, Inc. "E-Sub", "OverRoll", "Floating-Cone", "VRC", "W7", "W-Cone" and their respective logos are trademarks of JL Audio, Inc.
©2020 JL Audio, Inc. • Printed in U.S.A. For more detailed information please visit us online at www.jlaudio.com.



CAR AUDIO • HOME AUDIO • MARINE AUDIO • POWERSPORTS AUDIO

10369 NORTH COMMERCE PARKWAY • MIRAMAR, FLORIDA • 33025 • USA

SKU#97408 08-2020