



MOONRIVER AUDIO

MODEL 404

STEREO INTEGRATED AMPLIFIER

O P E R A T I N G I N S T R U C T I O N S

We, at MOONRIVER AUDIO, would like to thank you for choosing the MOONRIVER 404 integrated amplifier.

We spend 3 years in research and development to achieve this high level of performance. The same high performance is applied to the optional phono stage and the USB DAC.

As for the sound, we are not to say whether MODEL 404 is virtually transparent or inherently forgiving. Voicing it to appreciate the playlist and respect the user at all times has been the sum of all our effort;
A sincere effort to achieve effortlessness.

IMPORTANT NOTE: Before installing your new MOONRIVER AUDIO component, please read this manual carefully. It will inform you for proper installation, correct operating procedures and of the product specifications.



Contents

Important Safety Instructions	6
Unpacking And Installation	8
Box Contents	8
Introduction	10
Moonriver Audio	10
Made In Sweden	10
Moonriver Model 404	11
Design & Ergonomics	11
Modular Architecture	11
Features	12
Balance Control	12
Discovering The Layout	12
The Importance Of Tape Monitor Loop	13
Stereo/mono Switch	13
Optional Phono Stage	13
Optional Usb Dac	14
The Soft Start Function	11
MM/MC Phono Stage	15
Front Panel Description And Operation	16
Back Panel Description And Operation	17
Remote Control Operation	18
Specifications	19
Limited Warranty	20
Limits Of Warranty	20
Warning!	20
Troubleshooting	20



IMPORTANT SAFETY INSTRUCTIONS

Before using your MOONRIVER AUDIO component, carefully read the applicable items of these operating instructions and the safety suggestions. Please keep these instructions in a safe place.

Before connecting a MOONRIVER AUDIO component to your audio system, turn off all other equipment. Many audio components have automatic turn-on circuits that may potentially cause damage to electronic components and/or speakers. This type of damage is not covered by product warranties, and MOONRIVER AUDIO specifically disclaims responsibility for any such damage. Connect only to AC power outlets rated 220 - 240V 50 or 60Hz.

CAUTION: Do not open the chassis of the MOONRIVER 404 while the amplifier is on or plugged into an AC wall socket. There is high voltage inside.

Do not perform any service operations. Service is required when the unit has been damaged in any way, such as:

- mains socket is damaged
- liquid has been spilled or objects have fallen into the unit
- the unit has been exposed to rain or moisture
- the unit does not operate normally or changes in performance in a significant way
- the unit is dropped or the enclosure is damaged

Do not place the unit on an unstable box, stand, tripod, bracket or table. If the unit falls, it may cause injury to a person or damage to the unit. Mount the unit in a stable and safe place.

Slots and openings in the cabinet create ventilation to protect the component from overheating. These openings on the bottom panels must remain unobstructed. Allow at least 10 cm of clearance above the unit and an opening behind the unit for airflow. Do not place the unit on a bed, sofa, rug, built-in bookcase, or rack without adequate ventilation.

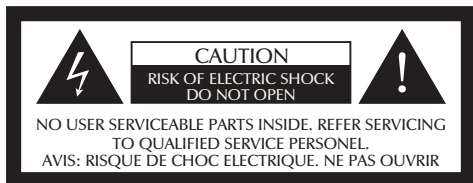

Do not place near heat sources, such as radiators, heat registers, or appliances which produce heat. Keep the rear of the unit at least 10 cm from walls or other items that might block heat radiation. Do not use the unit near water (swimming pool, bath tub, kitchen sink or laundry tub) or in a damp environment like a basement or outside in the rain.

Do not step on the power cords. Do not place items on top of power cords so that they are pinched or leaned on. Pay particular attention to the cord at the plug end and the point where it connects to the unit. Do not defeat the safety purpose of the ground plug. A grounding IEC type plug has two blades and a third grounding prong. The third prong is provided for your safety. When the provided plug does not fit into your outlet, consult an electrician to replace the broken or obsolete outlet.

Do not push objects of any kind into the unit through openings as they could touch dangerous voltage points and short-out parts, possibly resulting in a fire or electric shock. Avoid spilling liquid of any kind on the unit. If water or any metal object (such as a paper clip, coin, or staple) accidentally falls inside the unit, disconnect it from the AC power source immediately and contact Moonriver Audio for further instructions.

For added protection during a lightning storm or when is the component is idle for long periods of time, unplug the unit from the wall outlet. This will help protect the unit from lightning and power line surge damage.

Do not overload wall outlets, extension cords, or integral convenience receptacles as this increases the risk of fire or electric shock.

■ Unpacking and Installation

MOONRIVER AUDIO 404 integrated amplifier was shipped in a carton particularly designed to protect the contents. Special care has been taken to prevent damage during shipping. Carefully remove your new 404 amplifier from the packing carton and examine it closely for signs of shipping damage. If shipping damage is discovered, take photos of the damage, contact the transport carrier immediately and retain the packing as evidence. We strongly recommend saving all original packing cartons to protect your component for storage or future shipping.

Box Contents

User Manual x1

Power Cord x1

Remote Control x1

MOONRIVER MODEL 404 amplifier x1

Packing Material

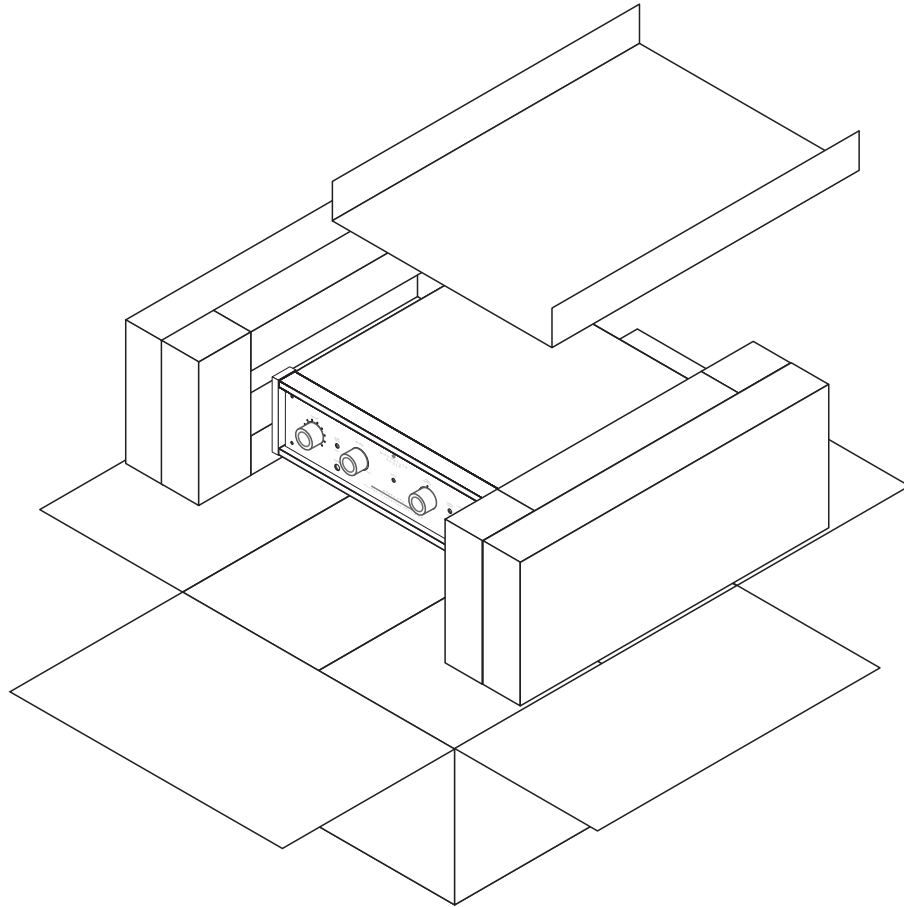

■ Introduction

Moonriver Audio

Inspired by the famous song, MOONRIVER AUDIO is a combination of the vintage and the contemporary in audio reproduction.

Classic, timeless, user oriented design. Organic texture acquired within an open space, dynamic behavior unrestrained while preserving natural color, provisions made for modular upgrades and direct access to all functions.

Moonriver loves vinyl records, analog tapes, compact discs and digital streams and features upgradable modules for all those formats. We employ every technology available today, without staying dogmatically exclusive to one design principle versus another, be it solid state, integrated circuit or vacuum tube.

We are fond of hybrid designs that fuse well known and fresh tech elements, but, most of all, that fit the application.

Made In Sweden

Our products are designed and made in Sweden. We hand-assemble each unit, a painstaking but precise procedure. Through a global inventory that is constantly updated, it is our sophisticated research, efficient development and extensive listening tests -the fun part- that lead us to select the right component for a no-compromise audiophile sound.

We also care for sustainability as well as for reliability. Moonriver products are covered by a 3-year warranty and are designed to last for decades without any need of maintenance.

Moonriver Model 404

is the outcome of a 3-year research, the aim being to achieve incredible performance regardless of price range. The 404 amplifier will extract hidden elements and render textures from within any audio format, with the source, speakers and room to set the limits. Its culture will suit all music, as the Model 404 is by design set to define the faintest nuances of which tone integrity is composed.

A hefty supply section ensures that ample healthy power is available at all times at all stages through separate rails. A fully discrete preamp section serves for acute dynamic awareness, while a high output stage that is custom-optimized for bandwidth and distortion warrants for neutral predisposition and transient fidelity. A laborious selection of components armors the design against tonal alteration, pretentious or not, thus preserving naturalness throughout the shortest feasible path.

Furthermore, an integrated phono stage, a USB DAC, two preamp outputs and a tape monitor loop expand functionality to form an ideally flexible integrated amplifier.

Design & Ergonomics

We had a very clear vision when we conceived the MOONRIVER 404 amplifier: Classic design with a modern touch; high quality materials such as massive aluminum knobs, solid walnut cheeks, sturdy enclosure; ergonomic user interface.

There are no “shaved” aesthetics here, no display with complicated serial menus and hidden functions, nor a single multi-function knob for “minimalistic” purposes.

The heart of MODEL 404 is pure and minimal but the interface is user oriented and easy to operate by anyone in seconds with no need to resort to the user manual. Four knobs and three switches give direct access to any function.

Modular Architecture

MOONRIVER 404 amplifier is modular by nature; it can accommodate an MM or MM/MC phono stage and a USB asynchronous DAC. Fitting these modules is quite simple and can take place at any time, on or after purchase. The USB DAC may also be upgraded with a newer version to meet future needs.

■ Features

Balance Control

You may find this feature to be vanishingly scarce in audiophile products as a result of today's "minimalist" design mentality and the various myths accompanying it. However, balance control addresses a common problem; speakers that are positioned in asymmetry, in a non-balanced room environment. It thus provides the simplest tweak towards achieving a proper sound stage.

Living rooms and house furniture are meant to serve everyday life and may not be provisioned with an ideal listening spot, evenly distanced from each speaker to form an equilateral triangle. It is also not uncommon for one speaker to have to be placed nearer room boundaries than the other, having various frequencies boosted in a more or less predictable pattern. More often than not, balance control would come in handy in that it drastically helps overcoming volume level unevenness and in some cases even reclaiming stereo effect and the resulting focused sound stage.

As expected, the way balance control is implemented on the MOONRIVER 404 amplifier, in parallel, will not degrade or affect the signal in any way determinable.

Discovering The Layout

MODEL 404 incorporates no less than 5 separate power supplies, each featuring overload protection. The power amplifier specifically runs on a dual mono configuration, beginning from separate windings on the toroidal transformer.

Signal switches are implemented via relays, while volume attenuation is trusted on the legendary blue ALPS pot.

A soft start circuit based on a 30A relay ensures that even the on/off switch is thought out to work with virtually no burden or wear for decades.

Components are carefully selected for both suitability and reliability. We make no use of surface-mount in analog circuits, despite the fact that through-hole costs more and requires advanced space management & layout strategies.

Each element utilized has to be of proven stability and sustained higher performance - proficient implementation provided- before making it into our analog paths.

Stereo/mono Switch

The pristine era of analogue recording being long gone, features like the stereo/mono switch have been gradually chased out into obsolescence. Who wants to go back to one when they have two channels? “Less is more” and “more is better”. Well...

With the resurgence and interest in vinyl, whether the current rage; fashion or a real movement, countless monaural pressings emerge out there, often along with their digital... image. Too many of them, among others waiting to be rediscovered, have currently become collector's items, 78 rpm direct-cut gems being no exception. This is not unreasonable, as what happened between say the 30s and the 80s in terms of both musical interpretation and recording technique is by many considered to be “most of the music” – this sentence doing perhaps no justice to stunning actual developments in creation and reproduction. The stereo/mono switch gives you the chance to enjoy recording art milestones with respect to how they were initially intended to please; in genuine mono, 2-channel, doing away with artificial phase discrepancies induced by a mandatory stereo mode.

So, 'less' may well be 'more', but 'better' is to have a choice.

The Importance Of Tape Monitor Loop

Most of today's manufacturers probably reject the idea of their product featuring a tape loop. At Moonriver Audio, it has been concluded that the tape monitor loop is essential. Not only does it add the option of monitoring the difference between recorded and source material in real-time, it also, and most importantly, makes possible to insert to the chain – at will – a digital or analogue room correction processor, a buffer, a noise reduction system or any other line device available to improve the sound of a connected source.

Optional Phono Stage

Model 404 comes with two options in the phono stage department; one is MM only and the other is MM/MC selectable. Both follow the exact quality principles that Model 404 is built on. Quality components and massive power supplies are also employed here, to efficiently accommodate very low noise, high performance op-amps.

Optional USB DAC

What was desired for our USB DAC module was not to make an addition rather than an omission; instead we had to be confident of substantially raising the true value and functionality of Model 404.

The Soft Start Function

Moonriver Model 404 features a sophisticated soft start circuit based on a 30A relay that ensures that even the on/off switch is thought out to work with virtually no burden or wear for decades.

It also protects the speakers from annoying “clicks and pops” and, at the same time, protects the amplifier from malfunction. Each time you push the power button, a microcontroller takes control over the relays of the amplifier: First, there is a delay of 2 seconds followed by the input relay that lights up. 2 seconds later the preamp relay connects the preamp output and 3 seconds later the output led lights up as well showing that the output stage is active.

MM/MC Phono Stage

The MM/MC phono stage can drive both Moving Magnet and Moving Coil cartridges. The gain is 40dB for MM and 60dB for MC and the input impedance 47Kohms and 100 ohms respectively. The input capacitance is fixed at 100pF.

In order to change the setting from MM to MC or vice versa you should change the position in 2 dual dip switches:

1. Turn off the power, disconnect the power cord, input and speaker cables.
2. Wait 1 minute while the capacitors are discharging.
3. Using a HEX screwdriver to remove the 10 screws of the cover (6 on the top and 4 on both sides).
4. Locate on the right side the nickel shield box and remove the 3 screws that hold it in place. Remove carefully the shield box by pulling it vertically.
5. The phono stage PCB is revealed. On the right side looking from the top you can find the dip switches. There are 2 dual switches: The left pair is for the left channel and the right pair for the right channel.
6. Change the setting according to the instructions of your cartridge. Moving Magnet cartridges work properly with MM setting and low output Moving Coil cartridges with MC setting. For MC high output type the correct setting is the MM in most of the cases.

WARNING: DO NOT change the setting of the dip switches with the amplifier turned on! This can cause permanent damage to the op-amps. DO NOT turn on the amplifier without the cover secured in place.

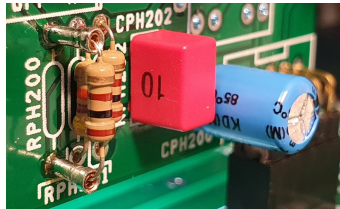

The MC input load can be set also, by replacing the original 100 Ohm input resistor with a higher or lower value. No soldering is required.

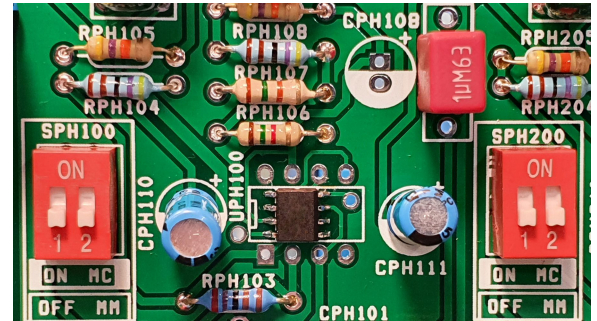

FRONT PANEL DESCRIPTION AND OPERATION

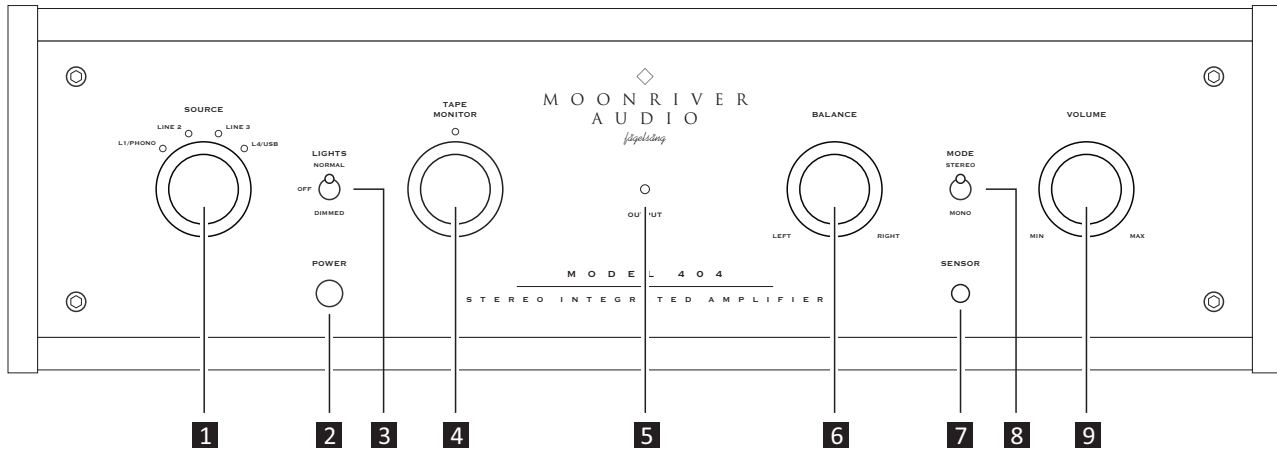

1 SOURCE SELECTOR

Turning the source selector clockwise selects the next line source and counterclockwise the previous one. There are 4 options from line 1 to line 4. Line can be converted to mm/mc phono stage and line 4 to asynchronous USB DAC.

2 POWER SWITCH

Turns the unit on or off. Off position doesn't consume any power. CAUTION: If you just turned off the unit, please wait at least 30 seconds before you turn it on again.

3 LIGHTS SWITCH

This switch changes the light's luminosity. There are 3 options: Normal, Dimmed (50% of the normal) and off.

4 TAPE MONITOR

Turning the tape monitor selector clockwise activates the tape monitor function and counterclockwise deactivates it and return to the selected source (1-4).

5 OUTPUT LED

It show the status of the output stage. When the mute function is activated by the remote the led is off.

6 BALANCE CONTROL

Turning the balance knob to the right, the left channel decreases progressively, while turning it to the left the same will happen to the right channel.

7 SENSOR

This mark indicates the position of the remote control sensor

8 MODE SWITCH

This switch swifts the signal from stereo to mono. It should be used to old monaural analog recordings.

9 VOLUME CONTROL KNOB

This controls the output level. This knob is coupled to a world class motorized Blue ALPS potentiometer.

BACK PANEL DESCRIPTION AND OPERATION

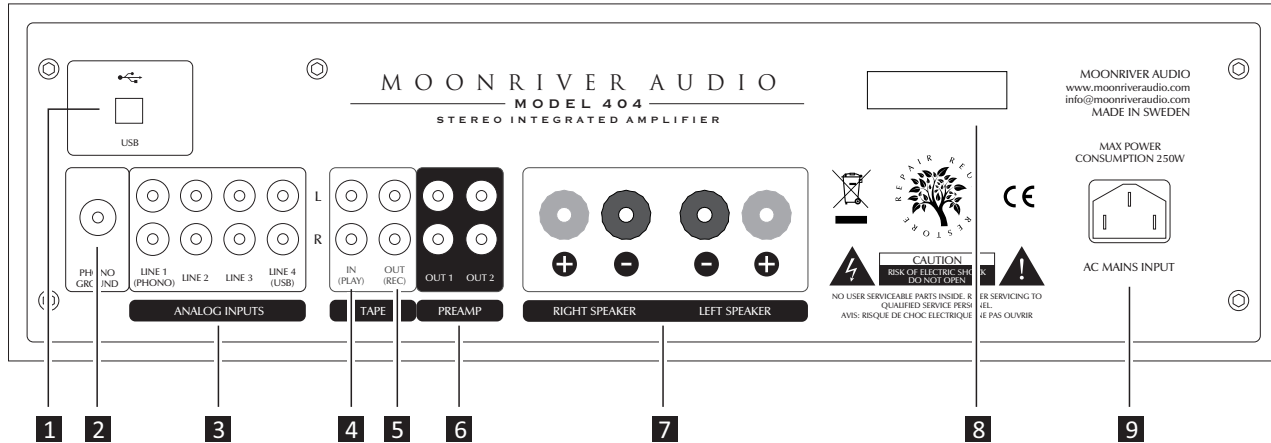

1 ASYNCHRONOUS USB INPUT

When the USB DAC is installed, a Windows 10 PC or an Apple Macintosh with OSX version 10.6.4 or above will work flawlessly with DXD files up to 384khz/32bit without the need of a driver.

2 PHONO GROUND

When a MM or a MM/MC phono stage is installed, the turntable ground must be connected in this terminal.

3 ANALOG INPUTS

There are 4 line inputs to connect your line sources. Note that line 1 can be converted to phono input. Also, when the USB DAC is installed, the line 4 is not working.

4 TAPE IN (PLAY)

This is an additional line input that is useful for monitoring a 3 head tape recorder, a tube buffer, a room correction device, etc

5 TAPE OUT (RECORD)

The record output can be used to connect a analog or a digital recorder, a headphone amplifier or, combined with the tape input, a tape recorder, a tube buffer, a room correction unit etc.

6 PREAMPLIFIER OUTPUTS

There are 2 outputs to drive additional power amplifiers or subwoofers. The output impedance is a few ohms.

7 SPEAKER OUTPUTS

These are the speaker outputs. Be sure that the left output is connected to the left speaker and the right output to the right one. The right polarity must be kept between the amplifier and the speaker to avoid wrong phase.

8 SERIAL NUMBER

The serial number carries useful information for the unit.

9 MAINS INPUT

Mains input must be connected to a grounded power line.

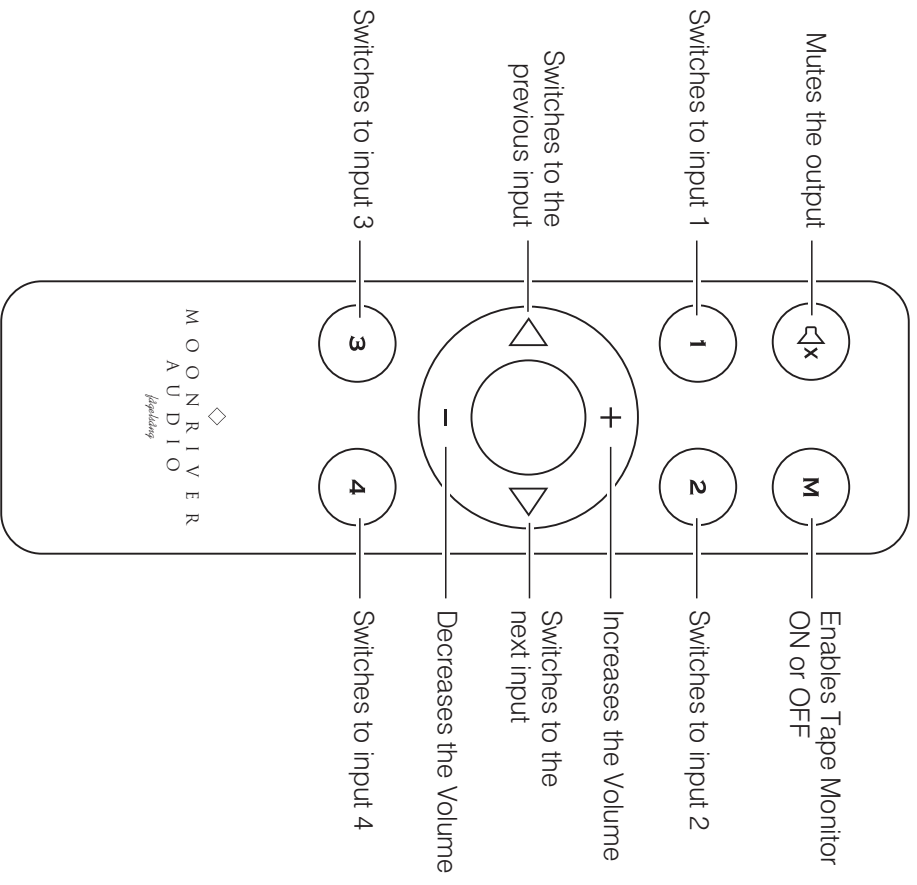

REMOTE CONTROL OPERATION

■ Specifications

Inputs:	5 (line 1 and 4 optionally occupied by phono stage and USB DAC respectively, 1 x tape loop)
Outputs:	2 x preamp out, 1 x rec out
Max. output power:	50 W per channel into 8 Ω
Frequency response:	10 Hz to 50 kHz
Total harmonic distortion:	0.05%
Signal to noise ratio:	85 dB (line)
Idle Consumption:	22 Watts
MM phono stage gain:	40dB
MC phono stage gain:	60 dB
MM input impedance:	47K Ω
MC input impedance:	100 Ω
Input capacitance:	100pF
Dimensions (mm):	430 (W) x 390 (D) x 135 (H)
Weight:	12,5 kg

Limited Warranty

MOONRIVER AUDIO warrants that your newly purchased hardware product shall be free from defects in material and workmanship for three (3) years, beginning from the date of purchase. Shipping charges are paid by the owner. Except where prohibited by applicable law, this warranty is non transferable and is limited to the original purchaser. This warranty gives you specific legal rights; you may also have other rights that vary under local laws.

Limits Of Warranty

This warranty does not cover problems or damage resulting from accident, abuse, misapplication, or any unauthorized repair, modification or disassembly; improper operation or maintenance, usage not in accordance with product instructions or connection to improper voltage supply.

Warning!

MOONRIVER AUDIO LABORATORY SHALL ALSO NOT BE LIABLE FOR ANY SPECIAL, INDIRECT, INCIDENTAL, OR CONSEQUENTIAL DAMAGES WHATSOEVER, CAUSED BY PROBLEMS IN THE MAINS ELECTRIC SUPPLY, NON PROPER USE OR USE WITH NON COMPATIBLE APPLIANCES WITH INCOMPATIBLE OPERATING VOLTAGE. IN ANY CASE THE LIABILITY OF MOONRIVER AUDIO LABORATORY IS LIMITED STRICTLY TO THE INITIAL VALUE OF THE UNIT. Some jurisdictions do not allow the exclusion or limitation of special, indirect, incidental, or consequential damages, so the above limitation or exclusion may not apply to you.

Troubleshooting

Incorrect operations are often mistaken for trouble and malfunctions. If you think that there is something wrong with this component, check all the connections, the power switch and the indicating lights. Sometimes the trouble may lie in another component. Investigate the other components and electrical appliances being used. If the trouble cannot be rectified even after checking everything, return your MOONRIVER AUDIO device to your dealer to carry out repair work.



MOONRIVER AUDIO Poststugan 532, 21165 Malmö, Sweden
www.moonriveraudio.com | Tel: +46765905066 | email: info@moonriveraudio.com